

A NEW APPROACH ON MODELING OF THE B-VIII, THE ULTIMATE ACHIEVEMENT OF THE SECOND “URANVERAIN”

by

Milan P. PEŠIĆ

Vinča Institute of Nuclear Sciences, University of Belgrade, Belgrade, Serbia

Scientific paper

<http://doi.org/10.2298/NTRP1801001P>

German Nazi state conducted researches in nuclear technologies as an attempt to achieve various military goals. As the result of these researches, German scientists developed different, advanced nuclear technologies in years before and during World War II. In an attempt to develop the “Uranmaschinen”, in which controlled release of high energy in fission process can be achieved, various approaches were examined, theoretically and experimentally. These studies were conducted under support of the German Nazi state and were known as the First and Second “Uranverain” (Uranium Society/Club). Versions of the “Uranmaschinen” were based, mainly, on natural uranium fuel and moderators of heavy water, regular water or paraffin. The latest known fission device was the subcritical nuclear fission reactor B-VIII, re-built in village Haigerloch, Bavaria, Southern Germany, in first months of 1945. It was a tank type device with natural uranium metal fuel and heavy water moderator, reflected by graphite. Radiation shielding of the device was achieved, primarily, by surrounding the reactor tank by regular water. The whole device construction was assembled inside a concrete hole in the floor of an underground cave, ex beer cellar. A recent neutronics study of this reactor was done, assuming fuel rods with lumped parameters approximation, by Italian Bologna University LIN (Laboratorio Ingegneria Nucleare) research group in 2009.

This paper is a new approach to the neutronics study of the B-VIII reactor with an attempt to model real fuel-moderator geometry. This study points out many approximations and simplifications, made during the B-VIII material composition and geometry modeling, due to missing data. The paper investigates the influence to criticality of numerous uncertainties in the material compositions, mass densities and geometry of the facility. The Monte Carlo MCNP6.1 code with the latest ACE type neutron nuclear cross section data is used for that purpose. Additionally, an attempt of estimation of the uncertainty of the experimental result of the neutron multiplication was given. Differences in the calculated values of the neutron multiplication and the experimental one are investigated and tried to explain. These analyses show that the B-VIII was a subcritical device, as it was shown by the experimental results of the German scientists achieved in March-April 1945 in Haigerloch.

Key words: Nazi nuclear program, B-VIII, neutron multiplication factor, MCNP6.1

INTRODUCTION

German Nazi state initialized and conducted (in the period from 1939 to 1945) research in nuclear technologies, as an attempt to achieve diverse military applications. As the result of this research, and research done in earlier years, German scientists developed different, advanced nuclear technologies in years before and during World War II (WWII). In an attempt to develop the “Uranmaschinen”, in which controlled release of high energy can be achieved, by thermal neutron induced fission process of uranium (metal or oxide), various approaches were examined, theoretically and experimentally. Thermalization of neutrons was achieved after fission neutrons were slowing down

* Author e-mail: mpesic@vin.bg.ac.rs

by different moderators: the heavy water, regular water and paraffin. Graphite was abandon as a moderator, according to Heisenberg [1] and Bethe [2], due to reported high absorption cross section obtained as a result of measurements conducted by Bothe and Jensen in 1941 [3]. These, the “Uranmaschinen”, studies, conducted under (mainly financial and organization) support of German Nazi government, were known as the First and Second “Uranverain” (Uranium Society/Club) [2]. Top German scientists, who remained in Nazi “Third Reich” during those years, were involved in the “Uranverain” program, including the Nobel Prize laureates like Werner Heisenberg and Otto Hahn. These key German scientists include also Walther Bothe, Paul Harteck, Walther Gerlach, Carl Friedrich von Weizsacker, Karl Wirtz, Kurt Diebner, Claus Clusius and Erich Bagge. In

spite of difficulties that influenced their work, like heavy war circumstances, international ban on spreading the information on nuclear research progress, including losing financial and political support as time progresses, less than a hundred of those scientists achieved very notable research and technological results. Their achievements and fails in scientific and military applications of nuclear technologies were examined and estimated from different aspects, including technical ones [4-16]. A brief overview of the research, related to construction of different versions of the "Uranmaschinen", including B-VIII, was given by Heisenberg, Bopp and Wirtz [17-23]. A part of their old, mostly classified, progress reports, is also available today to public in archives of the Deutsches Museum in Munich, Germany, in digital forms [20, 22, 24].

The examinations of different types of the "Uranmaschinen", using various forms of uranium fuel and moderators, were carried out at the "Uranverain" laboratories in several different German cities, including Berlin, Gottow and Leipzig. The versions of the "Uranmaschinen" were coded in the German reports by the initial letter of the city (where the experiments were done) and by the Roman (or Arabic) numerals (indicating chronological order of the particular device).

The ultimate device, which was achieved in the technological progress towards controlled neutron induced fission system, was the (subcritical) nuclear fission reactor labeled (by designers) "B-VIII" ("B8" or "B₈"), initially assembled at Kaiser-Wilhelm Institute (KWI) in Berlin in January 1945 [4]. Its construction was based after the "B-VII" ("B 7" or "B₇") version of the "Uranmaschinen", operated at KWI in Berlin during the last months of 1944. The B-VIII was never operated in KWI and was disassembled in February 1945 [4]. This was done due to unsafe experimental work carried out under heavy bombardment by the Allied Forces and due to the circumstance that Soviet army was approaching to the Nazi state capital – Berlin. The B-VIII construction elements were evacuated from KWI (by end of February 1945) by Lorries, supervised by E. Bage, to Southern Germany and re-built in village Haigerloch in South Bavaria, in March-April 1945 [4].

The B-VIII was a tank type fission device with the natural uranium metal (nUm) fuel and heavy water moderator, reflected by graphite. Radiation shielding of the assembly was achieved, primarily, by surrounding the reactor tank by regular, demineralized water. The whole device structure was re-assembled inside a concrete pit in the floor of an underground cave, ex-beer cellar under Haigerloch castle church. The B-VIII is still interesting to nuclear community due to complex fission core structure designed by German scientists and its possible criticality of the fission process. German scientists have reported that the neutron multiplication factor (M) of 6.7 was achieved in mea-

surement at the B-VIII, during operation at Haigerloch in March-April 1945 [17, 19, and 23]. The uncertainty of this experimental result was not given.

A recent neutronics study of the B-VIII was done by the LIN research group from Italian Bologna University in 2009 [25] under following assumptions and simplifications:

- the total 664 nUm cubes (no impurities mentioned) with mass density of 19.05 g cm^{-3} (considered as high purity nUm [26]) were used, arranged in the "U-Al chains" containing 8 or 9 nUm cubes per the U-Al chain. The nUm cubes were hanging in the U-Al chains using the cube vertexes. This last assumption was mentioned in [25], but due to homogenization in the lumped parameter "fuel" elements (see below), this assumption did not have any importance;
- the nUm cubes formed an uniform (circular) lattice in the D₂O moderator;
- the nUm cubes, the Al wire from each single the U-Al chain, and part of the D₂O moderator were homogenized in a lumped parameter "fuel" cylindrical rod with an equivalent diameter of $10/3 \text{ cm}$. This was done separately for the U-Al chains with 9 or 8 nUm cubes;
- the Al wires were assumed as double threads with 2 mm diameter made of Al type 5025, (with the composition given in tab. 1 [25]), which contains Mg as the major impurity;
- purity of the D₂O moderator was assumed as 95 % mol D₂O and remaining 5 % mol H₂O, without any judgment. This value of the D₂O purity increased neutron absorption in the system and consequently, gave a lower value of calculated neutron effective multiplication factor (k_{eff});
- the Mg (the inner) tank was made of AZ91 Mg alloy (composition given in tab. 1 in [25]) with wall thickness of 5 mm, instead of 3 mm. This increased wall thickness increased neutron absorption in the system and therefore, also reduced the value of calculated k_{eff} ;
- materials (32 kg Mg alloy and 75 kg stainless steel (SS), according to [17-19]) used for construction of the cover of the Al and Mg tanks, were neglected;
- domed top cover of the graphite, designed over the top cover of the Al tank, was neglected;
- the Al (the outer) tank was assumed to be made of Al 1100 alloy (see the composition given in tab. 1 [25]) with wall thickness of 2 cm, instead of 5 mm, which increased neutron absorption in the system and, as a result, decreased the value of k_{eff} , as well;
- three different types of graphite: pure graphite; graphite with impurities equal to 1 ppm (1 gg^{-1}) of equivalent boron content (EBC) [27]; and natural graphite, were assumed. The corresponding mass densities of graphite used in the modeling were given in tab. 2 [25], while the composition of the natural graphite was given in tab. 3 [25];

- the radial graphite reflector (GR), as well as the top and bottom GR, are assembled without any holes and hermetically sealed for entrance of the regular water;
- regular water covers up to the top of the pit above Al tank and domed top graphite cover and reflector, according to the sketch made by German scientists;
- the central chimney and the experimental tubes, including possible neutron sensitive probes in the tubes, were neglected;
- external neutron source in the core was neglected; and
- contributions of the neglected air voids and materials in the core, GR and water shielding, to the reactivity of the B-VIII, were estimated at value of about -0.035% , without any judgment or an explanation how this value was deduced.

The version 5 of the MCNP code [28] with the ACE continuous-energy neutron cross sections, at temperature of 293.6 K, selected from the actia, endf66a, endf66b, endf66c, endf60, rmccs, endl and Sab2002 nuclear data libraries, distributed with the MCNP5 code, was used.

This paper presents a new approach to the neutronics study of the B-VIII reactor. It shows an attempt to use, as close as possible, the real fuel-moderator geometry, accessible material and geometry data of the B-VIII components and points out many approximations and simplifications done during modeling due to missing data of the B-VIII. The paper investigates the influence to criticality of numerous uncertainties in the materials composition, mass densities and geometry of the facility. The version 6.1 of the Monte Carlo MCNP computer code [29] with the endf71 ACE type continuous-energy neutron nuclear cross section data, based on the ENDF-VII.1 library [30], was used for this analysis. Furthermore, both versions (5 and 6.1) of the MCNP code, tested extensively worldwide, *e. g.* at the Vinča Institute on the validation of the RB reactor experiments [31, 32], were used in same cases of analysis for a comparison.

As the Allies forces were approaching to Haigerloch, the German scientists removed the nUm cubes from the B-VIII and hide them, *i. e.*, buried in ground at a nearby field. The heavy water was also removed from the B-VIII to the storage and transport containers. Nevertheless, the Allies special task unit ALSOS (a mission consisting of military personnel and scientists) discovered the B-VIII place and most of the hidden nUm cubes [33, 34]. The ALSOS personnel dismantled by hands the B-VIII assembly by mid-April and moved most of the B-VIII components and documentation to the USA for the investigation. The majority of German top scientists who worked on the “Uranmaschinen” (*e. g.* Heisenberg, Hahn, Diebner, von Weizsacker, even the Nobel laureate Max von Laue, opponent to Nazi regime) were captured and transferred to Farm Hall, near Cambridge, U. K. The

replica of the B-VIII was built inside the Atomkeller Museum, housed in the cave under the Haigerloch castle, in 1979. The inauguration ceremony (in May 1980) was attended, among others, by K. Wirtz, C. F. von Weizsacker, and K. H. Hocker [21].

THE B-VIII DESCRIPTION

In this chapter a description of the B-VIII is presented, based on the material and geometry data published in many reports. Data (of technical character) presented in this chapter are extracted from several references [17-23] and are used to “construct” a three-dimensional (3-D) model of the B-VIII (shown in the next chapter). In a case when different data were shown in the references, the original articles or reports, written by German scientists involved in the B-VIII construction, were preferred in the modeling. The numerous uncertainties in material compositions, mass densities and geometry of the facility had influence to the criticality of the B-VIII. These uncertainties are examined, evaluated and tried to resolve in this article by the assumptions and simplifications made during the B-VIII modeling and calculations (chapter *Calculation results and discussion*).

According to [17-19, 23], the B-VIII was assembled in the concrete pit in the floor of the a cave. The Al tank was inserted and centrally located at wooden beams, placed at the pit bottom, first of all. Then, the bottom GR (height 45 cm, [20]) was built at the bottom of the Al tank. Next, the radial GR (about 43 cm thick, [20]) was built, also inside the Al tank, along inner surface of the wall of the Al tank, up to the height of the Al tank. The GR were built from prefabricated graphite blocks of the same size. The total amount of 1.5 t of the nUm, 1.5 t of the heavy water and about 10 t of graphite was available (mainly originated from the B-VII [20]) and used for design of the B-VIII. After that, the Mg tank (initially used in the B-VI) was inserted in the centre of the radial GR, built in the Al tank. The Mg tank was, then, covered (and hermetically sealed) with the top metal disk covering and sealing hermetically the Al tank as well. This top sealing metal disk was designed to carry the total weight of the nUm cubes, hanging at Al wires in 78 the “U-Al chains” below the central top graphite (thick 43 cm-45 cm, [20]), central top graphite reflector and the domed top GR, designed above the metal disk.

The vertical experimental tubes and the central chimney were inserted through the domed top GR to reach the Mg tank, the radial GR and water shielding. Some of these vertical tubes were also anticipated for insertion of Cd rods in order to stop neutron multiplication. Finally, the regular, demineralized, water was poured into the pit, around the Al tank. The sketch of the B-VIII, made by German scientists, shows that the water level covered completely the domed top GR,

above the height of the Al tank. The external neutron source was inserted through the chimney before the D₂O moderator was poured, step by step, into the Mg tank. Neutron multiplication was measured, using neutron sensitive probes, for each sequential stationary level of the D₂O in Mg tank, during such method of approaching criticality.

It was stated in [17-23], that the previous experiments had shown: “in accordance with the theory, that cubes were the best forms of {natural}* uranium {metal} in the D₂O moderator. The favorable dimension of the {natural} uranium {metal} cubes should be about 6 cm-7 cm according to the theory. From {Diebner's} attempts in Gottow, however, a larger number of {natural} uranium {metal} cubes of 5 cm edge were available {fig. 1}. It was therefore decided, with regard to the impossibility of producing sufficiently fast the {natural} uranium {metal} dices of desired dimensions, to produce further {natural} uranium {metal} cubes with edge of 5 cm to supplement the favorable ones”.

To be able to compare 'the cake forms' of new uranium fission device with the earlier ones, especially with the B-VI and B-VII, the B-VIII experiments were carried out in the same Mg cylindrical tank with the graphite blocks forming a radial reflector, as was used in the B-VI and B-VII. The previously used natural uranium plates in the B-VI and B-VII, were replaced by nUm cubes. For this purpose, the available 664 (680 mentioned once in [17-19, 21]), pieces of the nUm cubes were used. The total volume of 664 nUm cubes is 83 000 cm³. The total mass of 664 nUm cubes, for an assumed mass density of nUm of 19.05 gcm⁻³, is 1.58 t. The amount of 1.5 t of 664 nUm cubes gives the average mass density of nUm of 18.07 gcm⁻³.

Material composition of the nUm and its mass density were not given. Recent investigation, based on measurement of ⁸⁷Sr/⁸⁶Sr ratio in the sample, taken from one sample nUm cube discovered, and content of the Rare Earth Elements [33, 34], showed that the



Figure 1. Natural uranium metal cubes (photo taken from Atomkeller Museum at Haigerloch)

nUm cubes were produced using the uranium ore from Joachimsthal region (now Jáchymov in Bohemia) in Czech Republic. The nUm cubes, used for German Nazi program, were manufactured by the subsidiary Auergesellschaft, Berlin, of the German Gold and Silver Extraction Corporation “Degussa”, Frankfurt (now Evronik Industries AG), in 1943 [4, 33-35]. According to [35], the archives of the Auergesellschaft were destroyed in bombardment of Berlin during the WWII and data on the U metal production, from that period, do not exist in the archive of Evronik Industries AG, anymore. According to the [4] the U metal produced in Degussa contained “more impurities than the original {U} oxide, {used for the nUm production}, largely emanating from the calcium used in the reduction processes”. This statement was not supported by any reference in [4].

A cladding of the nUm cubes was not mentioned in German reports. However, according to [4], each nUm cube was lacquered with a new polystyrol emulsion to prevent the nUm cubes from chemical reactions with air or water and to provide a basic protection to operators from radiation. This emulsion was developed at the laboratories of the nUm manufacturer company and tested by Prof. Otto Haxel, who had found its neutron absorption to be negligible, *i. e.*, “virtually nil” [4].

The fission products and significant amount of Pu were not found [33, 34] in the nUm cube material, leading to a conclusion that the B-VIII had not achieved high neutron flux density (*i. e.*, the nUm was not burned-up). It was reported that the sample of the single nUm cube under investigation [33, 34] had 5 cm edge and mass of 2.4 kg, which gives mass density of the cube 19.2 gcm⁻³, slightly higher than theoretical one of the nUm: 18.95 gcm⁻³ [36] or 19.1 gcm⁻³ [37]. These data should be also taken with the caution since the uncertainties (tolerances) of the reported dimensions and mass were not given and only one sample of the nUm cube was under investigation.

In the latest information, received [38] from the same research group [33, 34] at EU JRC Institute for Transuranium Elements in Karlsruhe, Germany, the Inductively Coupled Plasma Mass Spectroscopy (ICP-MS) was used for measurement of the content of metallic elements in the sample of the nUm cube. The provided tab. A1 (in Appendix) of the elements composition of the sample of the nUm cube contains 25 metallic impurities with weight fractions in a the range of 1.3 ppm for Be to 1680 ppm for Fe. The weight fraction of the nUm, determined as a balance to 1.0, is calculated to 0.996634. The ICP-MS technique provided results with a relative uncertainty of 12 %. Boron was not listed in the tab. A1. Using data from tab. A1, the total EBC of impurities is calculated to about 7.1 ppm. Theoretical mass density of the nUm sample, de-

* text in {...} is added by the author of the article

terminated from these metallic element weight fractions and theoretical mass densities of the impurities and U, is calculated to 18.72 g cm^{-3} , which is lower than the one calculated from data reported for mass and dimensions of the sample.

The nUm cubes were inserted in the inner (Mg) tank of the B-VIII. This was done by the “U-Al chains”, made by Al wires attached on the central top GR of the Mg cylindrical tank. For the construction of the U-Al chains, small notches were made across edges of the nUm cubes, as can be seen at the photograph shown in fig. 1. It was written [17-19, 23] that these U-Al chains (78 total) were designed either with 9 nUm cubes (40 U-Al chains), or with 8 nUm cubes (38 U-Al chains), as can be seen in figs. 2 and 3. These two types of the U-Al chains were alternatively hanged below the central top GR in such a way {forming the “lattice”} that the distance between centers of two neighboring nUm cubes was about 14 cm [17-19, 23]. The U-Al chains with the nUm cubes were shifted for half of the reported distance of 14 cm (in respect to the height of the Mg tank) in aim to simulate the 'cake geometry', examined in previous (Gottow) fission devices with U plates and D₂O moderator. The radial hanging scheme of the U-Al chains (*i. e.*, type of the lattice) was not shown in the reports. The material composition, mass density and dimensions of used Al wires were not given.

The total amount of heavy water for the experiments was a collected as a mix of several D₂O batches sent, in the period from 1941 to 1943, to Nazi Germany from Norsk Hydro company, located in Rjukan at (German occupied) Norway. The Vemork hy-

dro-electrical plant of Norsk Hydro produced, as a by-product, the heavy water with purity of about 99 % mol D₂O (99.8 % [39], 99.76 % [42], 99 % [19-21, 40]). The uncertainty of this purity value was not given in the reports. On Nazi demand, the Vemork plant increased production of the heavy water manifolds, from 10 L per month, to 120 L per month in 1941 and, later, to over 200 L per month [17-19, 23]. The Allies air forces and Norwegian commandos, after a few attempts, succeeded to destroy the heavy water production line of the plant (1943) and sink the last shipment of the heavy water in Lake Tinn (Tinnsjo), in 1944 [39].

Exact purity and mass of the heavy moderator, used D₂O in the B-VIII experiments in March-April 1945, were unknown. The references give different values, from 95 % [25] to 99 % [19-21, 40] of D₂O molar content in the heavy water moderator and the total mass of about 1.5 t. It was known to German scientists that purity (molar content of D₂O) of the heavy water decreases with time due to absorption of moisture (H₂O) from air during experiments and handling. Therefore, German scientists had developed an electrolytic recovery technological process, in the KWI in Berlin-Dahlem, in which were able to recover purity of one ton of the heavy water in two months [19-20, 23]. That technological line was destroyed in bombardments of Berlin, shortly after beginning of operation [19-20, 23]. As an example, for the comparison, the initial (in 1962) 99.72 % molar purity of the heavy water of the RB reactor at the Vinča Institute of nuclear sciences (about 6 t) was decreased, in the period of the most intensive experimental works during operation

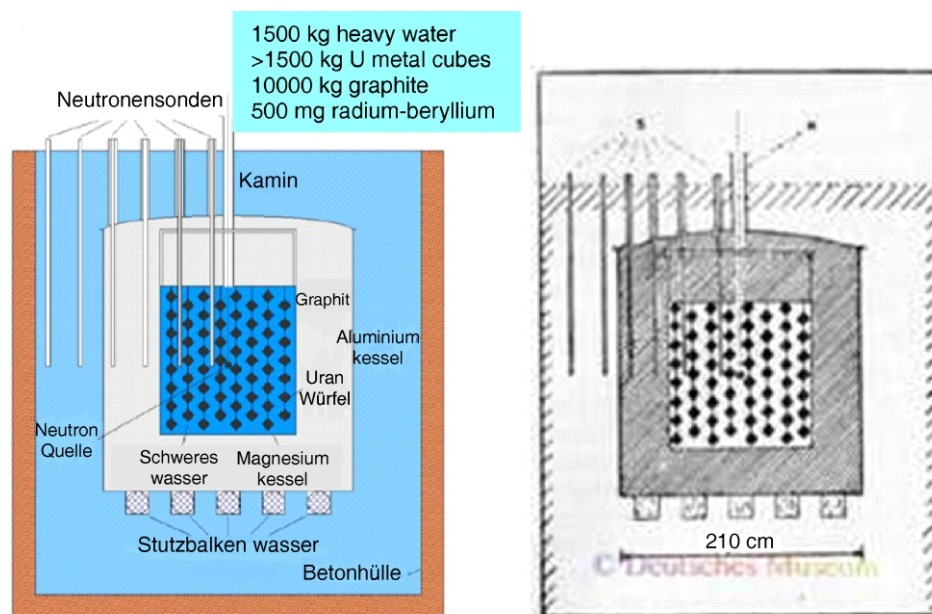

Figure 2. Sketch of the vertical cross section of the B-VIII construction in Haigerloch in 1945

(Legend: Neutronen quelle = external neutron source; Schweres wasser = heavy water; Wasser = water; Magnesium kessel = Mg tank; Aluminium kessel = Al tank; Uran-würfel = natural uranium metal cube in chains; Graphit = graphite; Betonhülle = concrete shell; Stützbalken = wooden blocks grate; Kamin = central chimney; Neutronensonden = probes for measuring neutron flux density distribution)

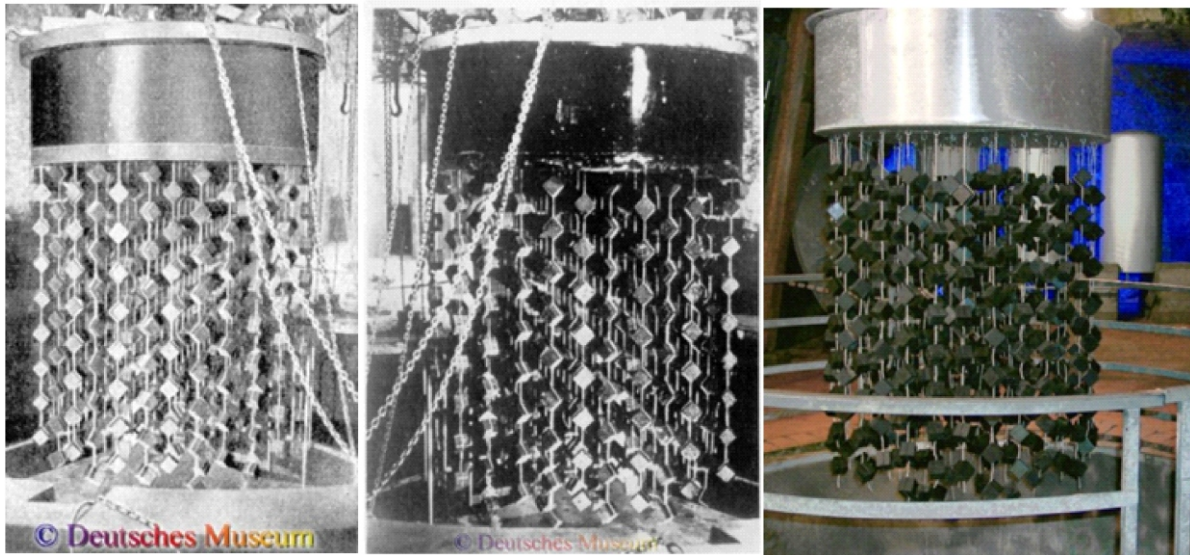

Figure 3. Top graphite reflector with chains of natural uranium metal cubes suspended below (photos taken from [22] and from the B-VIII replica at Haigerloch museum [last])

of the RB reactor [41], to 98.34 % molar (in 1970), *i. e.*, by average rate of about 0.15 % mol D₂O per year. Therefore, it is hardly to believe that normal handling of the heavy water, by German scientists during a few years, would reduce its purity below 98 % mol D₂O.

The central top GR of the Mg cylindrical tank of the B-VIII was constructed in order to be able to: (a) carry the mass (about 1.5 t) of the U-Al chains with the nUm cubes, (b) hermetically (watertight) close the Mg and Al tanks and (c) act as a top axial neutron reflector. The graphite belt (*e. g.*, the radial ring of the graphite having function of the primary neutron reflector) was, like in the B-VII, placed in between the inner, Mg tank and the outer, Al tank. All these construction elements led to the structure of the B-VIII experiment shown in the sketch in fig. 2, as a vertical cross section (along the device diameter) through the design of the B-VIII. The color sketch of the B-VIII (at the left side in fig. 2) is completely based on the black-and-white sketch (at the right side in fig. 2, taken from the [22]) made by German scientists, in the original papers [17-19, 22, 23].

The cylindrical Al tank was placed in a large water pool (which size was not mentioned), made with concrete walls (with unspecified thickness), in the floor of the laboratory (*i. e.* adapted underground pit). Material compositions, mass density and dimensions of concrete surroundings were not given. The Al tank (210 cm diameter, 210 cm height and 5 mm wall thickness, [17]; 210.8 cm diameter, 216 cm height and 0.4 cm wall thickness, [20]) was positioned on the wooden blocks (40 cm height [20]). All dimensions, material compositions and mass density of the wooden blocks were not given, neither their number. The water surrounding the Al tank was supposed to provide radiation shielding and (expected) cooling of the fission core. The water thickness along any direction was not

reported. Material composition (purity) and mass density of Al used for the Al tank and in the U-Al chains, were not given. The thermal neutron absorption cross section $\sigma_a = \sigma_{tot} - \sigma_s = 0.44 \text{ b}$ ($0.44 \cdot 10^{-24} \text{ cm}^2$) for Al, which was used in calculations by German scientists [20], is almost double one (0.23 b) as evaluated in the ENDF/B-VII.1 data library [30] and may indicate that that Al was not high purity.

The cylindrical Mg tank, taken from the B-VII, had diameter of 124 cm, 164 cm height and 3 mm wall thickness [4, 17-19, 23]. Material composition of Mg tank and its mass density were not given, but it was mentioned [19, 20] that the tank was made of the “Elektron”, which was a name, in the first part of the 20th century, for a range of Mg alloys with high content of Mg (about 90 %) and Al (up to 9 %) and other impurities.

The domed top cover (made of the graphite placed above a metal plate) was screwed at the top of the Al tank to provide water tightness. The domed top cover and the GR had openings for the central chimney, used for insertion the external neutron source (probably Ra-Be of 500 mCi Ra = 18.5 GBq Ra) in the Mg tank with U-Al chains (already inserted in the Mg tank). After that, the D₂O moderator was poured through the central chimney, into the fission core, assembled in the Mg tank. Dimensions and material composition of the external neutron source or the central chimney were not given. The domed top cover and the GR had also openings for experimental tubes, through which probes of a range of neutron sensitive materials (*i. e.*, Ag or Dy), or Cd neutron absorber rods, were inserted (from the top) in the B-VIII core, the radial GR and the radial water shielding. Material composition and dimensions (diameters and lengths) of the central chimney and the experimental tubes, their mass densities, or number and locations, were not given.

The central top GR was designed like a sandwich that fits in the Mg tank, inserted from the top. It was made of the graphite cylinder acting as an axial top neutron reflector. In aim to carry the complete structure of the nUm cubes lattice (U-Al chains), this top graphite cylinder was backed (at bottom side) by a metal cylindrical disk (fig. 3). This graphite cylinder had also, at the top side, a metal cylindrical disk used to seal the Al tank and Mg tank, as well. The entire top GR was designed below the domed top cover. The top dome was made of the graphite blocks above the top metal disk (fig. 2). The dimensions of the domed top cover were not reported. Material composition and dimensions of the metal disks and its their mass density were not given, either.

The Mg tank was surrounded by, about 40 cm, thick layer of graphite, designed of prefabricated rectangular graphite blocks of 5 cm 10 cm 50 cm [17] (5 cm 10 cm 44 cm, [20]). It was reported that existing graphite blocks were not appropriate to the B-VIII reflector size requirements [17, 19]. Tolerances of declared dimensions of the graphite blocks were not given, but it is hardly possible that graphite blocks had undamaged edges and surfaces after multiple manipulations during assembly processes of GR, in different facilities. Material composition (purity) of the graphite was not given, but was mentioned that it was 'relatively pure graphite' [25, 23]. The natural graphite may have the mass density in a the range of 2.1 gcm^{-3} to 2.3 gcm^{-3} [43]. It was reported that mass density of the used graphite was 1.7 gcm^{-3} [17, 20], *i. e.*, the same one as the nuclear grade graphite with the EBC less than 1 ppm [44]. Diffusion length for thermal neutrons in nuclear grade graphite is about 50 cm. To compensate for air gaps created during construction of the GR, an equivalent mass density of 1.58 gcm^{-3} for the graphite was used in calculations by German scientists [20]. This number also means that, in these calculations, a homogeneously distribution of the air gaps within the GR was assumed, with the equivalent average volume fraction estimated at about 7.1 % (since the air mass density is much lower than the one of graphite). The evaluated to-

tal cross section of thermal neutrons for pure C of $\sigma_0 = 4.94 \text{ b}$ (at 23.5 meV), according to data in the ENDF/B-VII.1 nuclear library [30], is very close (about 3 % higher) to one ($\sigma_0 = 4.8 \text{ b}$) that was used for graphite in the calculations done by German scientists [20].

A simple geometry analysis (section *Graphite reflectors modeling* in the next chapter) would shown that the graphite blocks (of the shape and dimensions given) would not fill completely the space of the ring between the Mg tank and the Al tank. It is difficult to see if any gaps were designed in the graphite mantle at the photograph (fig. 4, left), made during dismantling the B-VIII by the ALSOS team. Therefore, it could be assumed that the air space between the graphite blocks was filled with a graphite powder or much smaller graphite blocks, made of the same graphite material and the same mass density. A photograph (fig. 4, right) of the B-VIII replica at Haigerloch does not show any gaps in the radial GR, too. Moreover, a simple geometry analysis of this photograph would show that dimensions of the graphite blocks used in the B-VIII replica do not correspond to the reported dimensions of the graphite blocks [4, 19-20, 22]. The photograph at the left in fig. 4 also shows (in background behind the ALSOS staff) the top cover metal disk of the Al tank (at the left) and the D₂O storage and transport metal cylindrical containers (at the right).

The temperature of material components of the B-VIII during experiment was not known, but was assumed that all components of the B-VIII were at the ambient temperature in the cave. According to Heisenberg recalling "the spring 1945 in Haigerloch was fantastic warm weather and I was able to ride a bicycle" [45].

THE B-VIII MODEL

In aim to create a three-dimensional (3-D) model of the B-VIII, many simplifications and assumptions in geometry and material compositions of the B-VIII components are made. The data about B-VIII are taken from the published or internal reports. The simplifications are made for (complete or partially) known de-



Figure 4. ALSOS team dismantling B-VIII at Haigerloch in 1945 (left) and graphite radial reflector at B-VIII replica at Haigerloch (right), [46]

vice data which were evaluated and, after analyses, judged that may be omitted in the 3-D model, *i. e.*, that have (most probably) negligible effect on the neutron multiplication in the B-VIII. The assumptions are made for unknown (to the author) device data which are judged that should be included in the B-VIII 3-D model as necessary, because they could have non-negligible effects on the neutron multiplication.

The simplifications and assumptions

The simplifications in the B-VIII 3-D model include the following:

- size of the water pool was not mentioned in the reports, so the pool (pit) concrete walls and bottom are neglected due to the locations which are far away from the fission core;
- wooden blocks below the Al tank are neglected (*i. e.*, replaced by water) after a speculation that the mass density of the wood is close to the water mass density;
- small notches, cut across the edges of the nUm cubes, are neglected based on judgment that such small deviations in the geometry have small influence at criticality, *i. e.*, the nUm cubes are modeled with plain square faces and exactly 5.0 cm long edges;
- a thin polystyrol emulsion covering nUm cubes (with unknown material composition and thickness) was neglected due to the experimental conclusion by German scientist (O. Haxel) that such emulsion has negligible effect on neutron absorption [4];
- Al wires “hanging structure” of the U-Al chains, designed and attached below the top GR bottom metal disk, is neglected based on the facts that material and dimension data about this hanging structure are unknown from the reports and its location is at the top of the fission core;
- part of the Al wires that were wound up along faces of the nUm cubes are neglected in the geometry of the 3-D model of the B-VIII. To account their contribution to neutron absorption in the B-VIII fuel cells, their total mass is “added” to the Al wires, placed between the nUm cubes, as a small increase to the Al wire (equivalent) diameter, set to 1.11 mm;
- a part of the materials used to support the construction of the cover of the Al and Mg tank, [17-19, 23], due to missing dimensions and locations, is simplified in the 3-D model as two Mg disks and one SS disk. The SS support disk is completely neglected in the 3-D simple model since it was located far away from the U-D₂O core and, therefore, judged to have a negligible effect on the neutron multiplication;
- the domed top graphite cover is neglected due to missing dimensions and its distance from the fission core in the Mg tank;
- the external neutron source in the B-VIII fission core and its support structure are neglected as well, due to unknown data on the support structure, source neutron intensity, material composition, precise location and dimensions. This was also feasible due to possibility of the computer code used (MCNP, [28-29]) to determine the k_{eff} without modeling existence of the real external neutron source in the fission core. Therefore, as it is known from the fission reactor theory for a subcritical system with external neutron source [47], the k_{eff} is connected to the neutron multiplication (M), after transient time of neutron population vanished [48], by a simple relation:

$$M = \frac{1}{k_{\text{eff}}}$$

- the vertical central tube (chimney) and the vertical “experimental” tubes (located along Al tank radii), used for neutron sensitive probes, as well as the openings made for these construction elements in the domed top graphite cover, the GR and the water shielding, are neglected. This conclusion is based on the judgment that these elements, located in the GR and water shielding, have a small contribution to neutron multiplication in the B-VIII core, since the holes were far away from the fission core. It is believed that material of the tubes and chimney (eventually) immersed in the core, GR and water shielding, had also small neutron absorption effect in the B-VIII core, due to small amount of the material. These experimental tubes and chimney, including air inside them, are replaced, in the 3-D simple model, by the surrounding materials: the D₂O moderator in the core, the graphite in the reflectors and the water in the water shielding. This replacement of the materials in the 3-D simple model, consequently reduces the neutron leakage, what in turn, contributes to increase of the k_{eff} calculated for the 3-D simple model of the B-VIII; and
- inserted (likely) neutron sensitive probes (foils, wires) and their support elements in the experimental tubes, were neglected.

The assumptions during Monte Carlo calculations include ones made due to missing neutron cross sections data for particular isotopes in the endf71 ACE continuous energy neutron data library. The assumptions in the 3-D model of the B-VIII include ones made for materials and geometry data:

- dimensions of all neighboring material zones of the B-VIII 3-D simple model are matching exactly at contacts surfaces, without any gaps;
- due to unknown thickness and composition of the concrete walls and bottom of the water pool, the size of the water shielding is limited at 60 cm thickness around the Al tank (as in [25]), *i. e.*, more than 10 diffusion lengths for thermal neutrons;

- there are no air gaps between the graphite blocks included in the 3-D simple model of the B-VIII, *i. e.*, there are no damaged edges or surfaces of the graphite blocks;
- the same (assumed natural) graphite material (with reported mass density of 1.7 gcm^{-3}) is used for all graphite elements of the B-VIII construction;
- thickness of the top (radius equal to $62.0 \text{ cm} + 43 \text{ cm}$) and bottom (210 cm diameter) graphite in the 3-D simple model is assumed either 40.0 cm or 50 cm ;
- in the 3-D simple model, the radial GR is completely filling the space between the Mg and Al tanks, *i. e.*, its thickness is 42.7 cm ;
- two axial metal disks of the central top GR are made of the same material as the Mg tank, *i. e.*, of the most widely Mg alloy: AZ91D. The diameter of both the disks is 124.6 cm , while the thicknesses of the disks are 1.0 cm (bottom) and 0.5 cm (top). The disks are modeled without any gaps. The AZ91D alloy has mass density of 1.81 gcm^{-3} and the same composition, assumed by the LIN research group. In the 3-D simple model, the central top GR is modeled with a single (top) AZ91D disk (with equivalent thickness of 5 cm);
- material compositions and mass densities for all materials are assumed at $20.0 \text{ }^\circ\text{C}$ (except D_2O , H_2O or air, see below);
- for a feasible study of the B-VIII criticality, the “100 % pure materials” (*i. e.*, without any impurities and with theoretically mass densities at $20 \text{ }^\circ\text{C}$) are taken from [36, 37], except for the air which is assumed at Haigerloch pressure and temperature of $20 \text{ }^\circ\text{C}$;
- the total of 664 nUm cubes are used, arranged in the U-Al chains containing either 8 or 9 nUm cubes per the U-Al chain (total 78 U-Al chains);
- as a consequence of information given in [4 and 35], the nUm material is assumed in 3-D simple model with impurities content equal to 5.0 ppm EBC to account for any imperfections in technological processes of the production of nUm at the time of WWII. This EBC value is higher than typical EBC value (about 0.5 ppm) in nUm direct ingots (which enter to an nUm fuel production line) at 1950-s [49], or typical impurity content of 2.5 ppm EBC in the nUm produced in NCCP, Russia [50]. An analysis of variation in the EBC of impurities in the nUm in the range of 1 ppm to 20 ppm , is done for the 3-D simple model. The nUm mass density of 19.05 gcm^{-3} , the same one of the LIN research group [25], is used;
- the vertical distance between centers of two neighboring nUm cubes in one U-Al chain is always 14 cm , while a distance between two neighboring nUm cubes belonging to two adjacent U-Al chains depends on the (assumed) fuel cell lattice type, but it is around reported (14 cm) in the B-VIII (section *B-VIII fuel cell model* of this chapter);
- the Al wire, used to construct the U-Al chains, is assumed to be of Al alloy 5025 type with the mass density of 2.64 gcm^{-3} , the same one used by the LIN research group [25] in their study. Its material composition is taken from [25], as well;
- the material of the Al tank is assumed to be Al alloy 5051A, which is the oldest (1983) German Al alloy reported in Aluminum Association Inc. (USA) publication [51]. Hence, its composition and mass density of 2.69 gcm^{-3} are taken from [51]. It has only slightly higher thermal neutron capture cross section ($\sigma_c = 0.261 \text{ b}$) than Al type 1100 ($\sigma_c = 0.240 \text{ b}$), assumed and used by the LIN research group [25]. The Al alloy 1100 is reported in [51], by the USA in 1954;
- the heavy water moderator composition (D_2O molar purity) is assumed in the range of $89 \text{ } \%$ mol to $99 \text{ } \%$ mol D_2O at different ambient temperatures. Mass density and atom densities of the D_2O moderator are calculated, at supposed temperature and purity, using formulae shown in [41], taken from the LATREP code manual;
- the graphite material, declared as the “relatively pure” [17-19, 23] is assumed with impurities equivalent to 10 ppm EBC, assuming a variation of the EBC in the range of 1 ppm to 20 ppm . The natural graphite used by the LIN research group contains impurities equivalent to 4.212 ppm of the EBC;
- the level of the D_2O moderator in the B-VIII core was not reported in the reports. Simple calculations show that if all the reported amount (total mass of about 1.5 t) of the D_2O moderator was poured in the Mg tank with the U-Al chains inserted, the level of the D_2O moderator in the Mg tank was 119.79 cm for an amount exactly to 1.5 t . Therefore, if the level of the D_2O moderator was assumed at 124.0 cm in the 3-D simple model, *i. e.*, up to the bottom metal disk of the central top graphite cover, it would assume the total mass of the D_2O moderator of 1.65 t ;
- the two disks in a “sandwich type” of the top graphite cover are assumed to be made of Mg AZ91D alloy with diameter of 124 cm and thickness of 1.0 cm (at bottom) and 0.5 cm (at top);
- an assumption is made that the “sealing disk” of the Al tank is made of SS 340 type with mass density of 7.7 gcm^{-3} and composition taken from [44], with diameter of 211.0 cm and thickness of 1.0 cm ;
- the light (regular, demineralized [19, 23]) water (H_2O) is assumed at temperature and pressure of ambient air in the cave, with a natural content of the D_2O ($0.0115 \text{ } \%$ mol);
- the air is assumed at ambient temperature and at pressure equivalent to Haigerloch cave altitude (about 440 m). Average air ambient temperature in Haigerloch in spring time (March-April) is about $6 \text{ }^\circ\text{C}$ (the MSN weather web site: <http://msn.com>).

Variation of the cave average air ambient temperature is assumed in the range of 5 °C to 20 °C;

- the fuel cell lattice of the B-VIII reactor was not reported. In this study, different types of lattices are examined: the hexagonal lattice, the square one and the circular-uniform one (like the LIN research group used). The constrain for all used lattice types was to keep the distance between centers of two neighboring nUm cubes around 14 cm;
- the cross sections of all isotopes of Ar in the air are replaced by cross section of ^{40}Ar only;
- due to missing data for the cross sections for ^{18}O isotope in the endf71 neutron data library, its small atom fraction is added to atom fraction of ^{16}O isotope, because these isotopes have similar neutron total cross sections [52].

B-VIII fuel cell model

The 3-D fuel cell of the B-VIII is modeled as a unit with the face side length (edge, a) as close as possible to (around) 14 cm to fulfill reported (approximately 14 cm) distance (d) between the centers of two neighboring nUm cubes (in 3-D space). Height (in axial direction) of the fuel cell is set to $h = 14$ cm exactly, *i. e.*, it is a distance (d) between two nUm cube centers on the same U-Al chain. Exact dimension of the fuel cell edge a (in the radial direction of the Mg tank) in the 3-D model depends of on assumed type of the fuel cell lattice geometry:

- square ($a = 12.0$ cm, $d = 14.07$ cm),
- hexagonal ($a = 7.0$ cm, $d = 13.53$ cm), or
- LIN uniform-circular (average radial distance between neighboring concentric rings of the U-Al chains is 11.51 cm, while the distances between two nUm cubes in neighboring rings, measured in 3-D space is around $d = (13.5 \pm 0.8)$ cm, depending on the nUm number along circumference of the rings.

It should be underlined that these 3-D models of the fuel cell do not entirely satisfy the reactor theory requirements for a symmetry with adjacent fuel cells in a horizontal directions. However, the symmetry is satisfied for every second fuel cells. Nevertheless, such fuel cells are used in the modeling because they provide easy insight in a dependence of the k_{∞} from different material and geometry parameters of the fuel cell (section *Fuel cell infinite multiplication factor* of the next chapter).

If an assumption is made that required distance between two neighboring nUm cubes of 14 cm, which is the distance between two neighboring U-Al chains, then the fuel cell would have the side length (edge) of $a = 14$ cm. This option would not satisfy requirements of the total 79 radial distributed fuel cells (78 U-Al chains and one cell containing the central chimney) in the Mg tank with the radius of 62.0 cm, but only 61 fuel cells would fit in the core area.

Another possible case is an option that the fuel cell has side $a = 7.0$ cm, which provides that the distance (d) between two nUm cubes is 14.0 cm as well, but the nUm cubes should be at the same height, *i. e.*, in every second U-Al chain. This design would create, for 79 square fuel cells of the U-Al chains, a U-D₂O core with an equivalent radius of 35.1 cm and a radial D₂O reflector, to inner surface of the Mg tank wall, with a thickness of 25.9 cm. This was not the case in the B-VIII design.

The fuel cell contains the D₂O moderator with the fuel of the nUm cube (with 5 cm edge) located in the center of the fuel cell and the Al (5025A type) hanging wires (with equivalent radius of 1.11 mm) used to fix the nUm fuel cubes in the U-Al chain. The Al wires, in the 3-D model, are assumed that may (regardless the real case in the B-VIII) depart vertically from:

- the center of the opposite cube edges (the “Edge” nUm cube model = “E” model), or
 - the cube opposite vertexes (the “Vertex” nUm cube model = “V” model), or
 - the middle point at the cube opposite faces (the “Face” nUm cube model = “F” model),
- and extend to the centers of the opposite faces of the fuel cell.

The examples of the 3-D models of the square (left) and hexagonal (right) fuel cell are shown in fig. 5, where the model of the nUm cube is the “Edge” (left) or the “Vertex” (right).

B-VIII 3-D simple model

The 3-D simple model of the B-VIII is constructed after all (reported, assumed and estimated) material, geometry data and the simplifications, shown in sections *The simplifications and assumptions* and *B-VIII 3-D simple model* of this chapter, are used. There are no gaps in the 3-D simple model. This 3-D simple model is the closest to the one used in the study of the LIN research group [25], except for modeling of the fuel and the top cover sealing. Only the top Mg disk of the central top GR is modeled in the 3-D simplified version. The 3-D model of the B-VIII fission core, assembled in the Mg tank, assuming the square lattice pitch for the U-Al chains with the Vertex model of the nUm cubes, is shown, as an example, in fig. 6. The Al wires of the U-Al chains are not shown in fig. 6 deliberately, due to their very small (radial) dimensions compared to scale of the core.

The fig. 7 shows the vertical (along diameter) and horizontal (at elevation of 56 cm above the bottom of the Mg tank) cross sections of the B-VIII 3-D simple model. In the central part of fig. 7, the square lattice fuel cells are shown with the Edge model of the nUm cubes in the D₂O moderator (height 124 cm). In this 3-D simple model of the B-VIII, the GR (thick 40 cm)

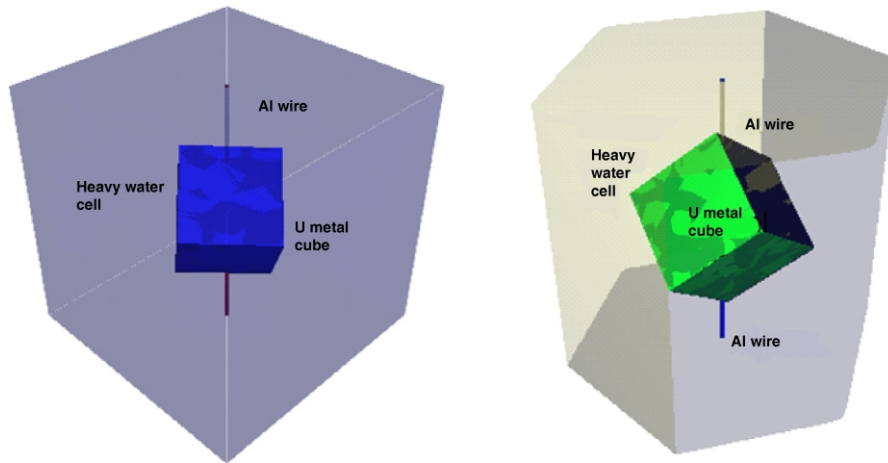

Figure 5. 3-D models of the fuel cells: the nUm cube Edge model hanging in the square fuel cell (left) or the nUm cube Vertex model hanging in the hexagonal fuel cell (right)

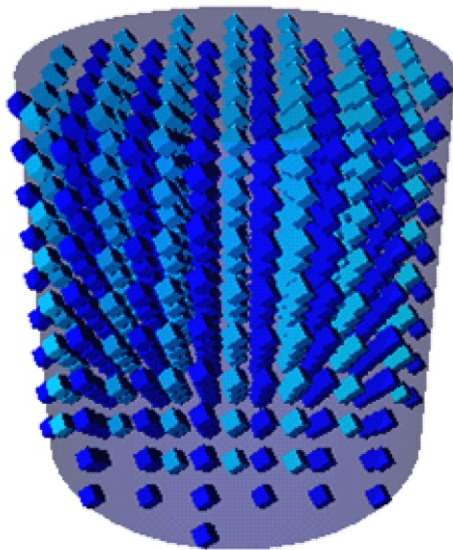

Figure 6. The 3-D model of the B-VIII fission core in the Mg tank

and the water radiation shielding (thick 60 cm) are around the reflected core and completely fill the space occupied. The walls of Mg tank and Al tank are not clearly visible in these geometrical cross sections due to their small thickness compared to the total scale of the B-VIII 3-D simple model. Therefore, fig. 8 shows only enlarged part (*i. e.*, a zoom in the top right corner) of the top GR above the Mg tank wall, the wall of the Al tank (extended through the top water shielding in this 3-D simple model) and the top AZ91D disk (thick 5 cm).

Graphite reflectors modeling

In the real design of the GR of the B-VII/B-VIII, German scientists were faced with the classical problem of “squaring the circle” inside cylindrical Al tank. The first possible case of the GR actual design may assume that, according to [17-19], the GR were

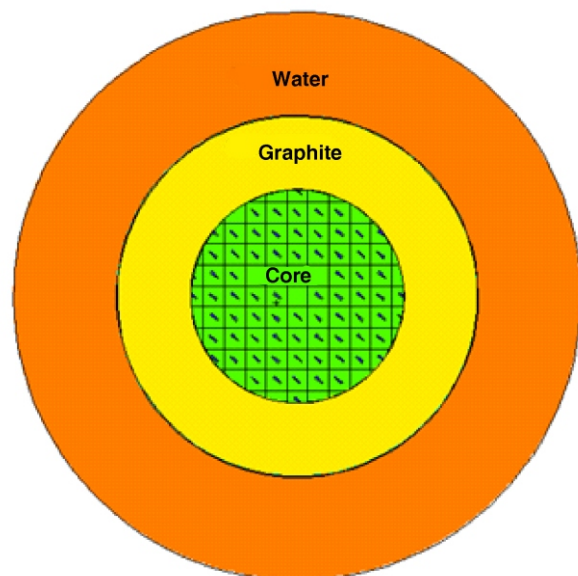
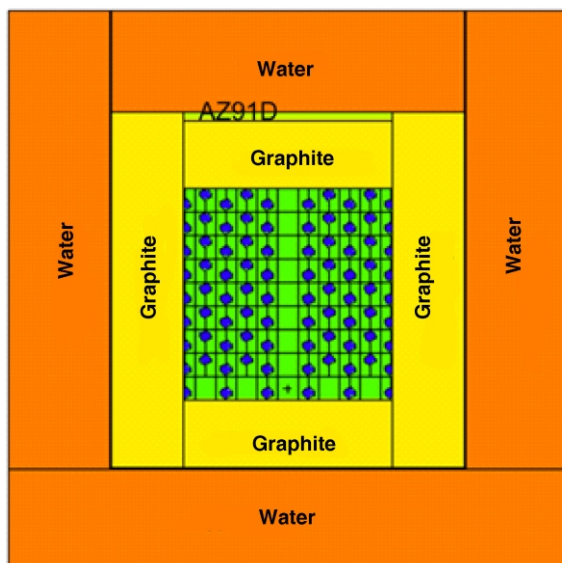

Figure 7. The vertical (left) and horizontal (right) cross sections of the B-VIII 3-D simple model

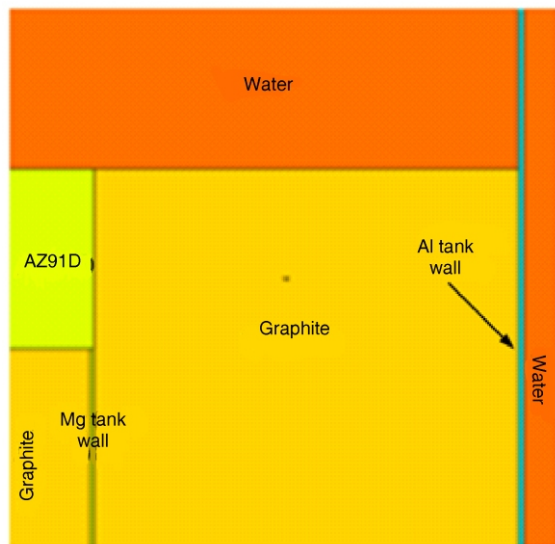

Figure 8. A zoom in vertical right corner of vertical cross section of the B-VIII 3-D simple model

built from prefabricated graphite blocks of the same size: $5\text{ cm} \times 10\text{ cm} \times 50\text{ cm}$. Tolerance of these dimensions were not given and, in these analyses, it is assumed that edges and surfaces of graphite blocks were not damaged. The volume of the graphite block is 2500 cm^3 . Reported total mass of the graphite was about 10 t. Taking the reported value of 1.70 gcm^{-3} of the graphite mass density, a simple calculation would show that mass of a single graphite block is 4.250 kg. Consequently, the 2350 graphite blocks were contained in 10 t. Total volume of all 2350 graphite blocks is 5.875 m^3 . Total volume of the space existing for three (top, bottom and radial) GR in the B-VIII was approximately between 5.65 m^3 and 5.97 m^3 , depending on the height (210.0 cm or 216.0 cm) of the Al tank. The lower volume would require about 2260 (or 2390) graphite blocks to completely fill the space (without gaps). We may conclude, after a simple geometric analysis shown below, that, if no other forms (*e. g.*, powder or much smaller pieces) of graphite were used in the GR construction, the reflectors were constructed with gaps between the graphite blocks.

A straightforward geometric analysis shows that the densest graphite “covering” of the circular or ring spaces of the radial and axial (top and bottom) reflectors could be achieved if the graphite blocks were placed with the shortest edge (5 cm) to the inner surface of the Al tank wall and with the 10 cm edge pointing in the radial direction to the centre of the Al tank. Therefore, the longest edge of the graphite block should be positioned vertically, *i. e.*, the graphite blocks should lie down on their $5\text{ cm} \times 10\text{ cm}$ faces. The longest edge (50 cm, or 44 cm in the other case) of the graphite blocks would not fit in the radial direction in the space (with the radial thickness 42.7 cm) between the Mg tank and Al tank. This analysis does not include evaluations and corrections due to unknown uncertainties in dimension toler-

ances of the graphite blocks and (probably a tiny) gaps among two adjacent graphite blocks, during assembling process. Such possible design would provide a height of 50 cm (or 44 cm) of the bottom and top axial GR. It would require also four lateral circular rows in the radial graphite mantle, between inner wall of the Al tank and the space occupied by the central Mg tank. The thickness of the graphite mantle would be 40 cm. Such design would leave an air ring space, between the Mg tank outer wall and the closest graphite blocks, thick of about 2.7 cm, wide enough for the insertion of the Mg tank along vertical axis of the Al tank. One such lateral row of this design would contain 395 graphite blocks in the radial reflector. Four lateral rows in the Al tank would be necessary to achieve the total height (of 200 cm or 167 cm), which will include the height (50 cm or 44 cm) of the bottom reflector, the height (124 cm) of the fission core in Mg tank and the height (50 cm or 40 cm) of the top reflector in the Mg tank. Hence, such construction of the radial reflector would require a total of 1580 graphite blocks.

The densest bottom GR, below the Mg tank, would be built from only one, single lateral row of the graphite blocks placed on their $5\text{ cm} \times 10\text{ cm}$ faces. Each of the five possible circular rows would be assembled from the maximum number of the graphite blocks (190). The same, or very similar, design could be arranged for the top GR, inserted at the top of the Mg tank. The holes between graphite blocks in the top GR would allow easy penetration of the central chimney and the experimental tubes.

Such a design of the GR would require two central (single block height) rows of the GR (under the Mg tank and inside it, at the top), each made of 190 graphite blocks. Hence, the total amount of 1960 graphite blocks would correspond to about 83.4 % of all graphite blocks. The total mass of graphite would be of about 8.3 t. Additionally, some number of the (broken or whole) graphite blocks would be used to fill the space of the central hole in the bottom GR and to build the graphite “domed top cover” shown in fig. 2, at the original sketch of the B-VIII. A sketch of the above mentioned version of GR possible design is shown in fig. 9 (left). The central circular part shows the graphite blocks at the bottom of the Al tank (*i. e.*, below Mg tank). The outer ring shows arrangement of the graphite blocks in the one of four lateral rows of the radial graphite mantle and outside radius of the Mg tank. A disadvantage of this design option is that the total height of the bottom and radial GR would be higher than the top edges of the Al and Mg tanks, what would require a design of a complex sealing system for the both tanks.

The same, fig. 9 (left), is valid if the graphite blocks of $5\text{ cm} \times 10\text{ cm} \times 44\text{ cm}$, from the B-VII design [20], were used. In this case, the volume of a single graphite block is 2200 cm^3 and the mass 3.740 kg, for the mass density of 1.7 gcm^{-3} . Ten tons of the graphite

would contain about 2670 graphite blocks. The similar number of graphite blocks would be used for construction of the radial reflector, as in the previous case of larger blocks. The height of four axial layers would reach 176 cm, including height of the bottom GR of 44 cm (the first layer), in the Al tank. If the height of the Al tank was 216.0 cm [20], five layers would get to 210.0 cm in the Al tank. The top GR would be designed in an analog way as the bottom one, with additional (maybe broken) graphite blocks used to fill the remaining gaps. A design of the sealing metal disk of the Al and Mg tanks would be more complex in the case of 216.0 cm height of the Al tank than in the case of 210 cm height.

Another possible version of a real design of the GR is shown at the right side in fig. 9. The graphite blocks would be assembled at the bottom cylindrical space in the Al tank (radius of 105.0 cm) with 10 cm 50 cm (or 10 cm 44 cm) side laying down, up to a height of nine layers (45 cm). Such a design would require 54 whole graphite blocks per layer, *i. e.*, the total of 486 graphite blocks (in the case of 50 cm edge). Similar arrangement could be used in design of the top GR, thickness about 40 cm. An unknown number of the broken graphite blocks would be used to fill the gaps created by such a design. The radial GR with thickness of 40 cm would be designed by laying the graphite blocks on 5 cm 10 cm side in three vertical layers (150 cm height) above the 45 cm thick bottom GR, in the same way as it was explained in the paragraphs above. The arrangement with 44 cm-45 cm thick bottom GR would provide that the top edges of the Al tank (210 cm height) and Mg tank (164 cm height) reach almost the same level, what would facilitate a design of the sealing metal cover. The top level of the radial GR would be about 15 cm, or about 33 cm (in the cases of 50 cm or 44 cm graphite block edge

length, respectively), below the Al tank top edge (210 cm). This ring shaped gap would be filled with some number of the broken graphite blocks, too. The gaps would remain in the design of the top and bottom GR, while the radial GR would be without any gaps, up to possible construction level. Such a design would create a 2.7 cm thick gap between the Mg tank outer wall and the inner surface of the radial GR. The total number of the whole graphite blocks would be similar to the one estimated in the previous version of the design.

B-VIII 3-D upgraded model

The B-VIII 3-D upgraded model is constructed after all reported, assumed and estimated material and geometry data and the simplifications, shown in the previous sections of this chapter, are used. Contrary to the LIN research group model, the square lattice of the U-Al chains with the Edge model of the hanging of the nUm cubes was selected for the 3-D upgraded model. This selection is judged as the easiest technically designed option, according to the notches made at the nUm cubes and shown in fig. 1. Main upgrades are as follows:

- composition of the nUm (with an equivalent EBC of 7 ppm [38] and the mass density of 19.05 gcm^{-3}) is accepted, assuming that all nUm cubes used in the B-VIII were from the same production batch. The last assumption is not most likely true, since the nUm cubes were delivered by the manufacturer to various “Uranverain” laboratories during a period of several war years and collected for the B-VIII design;
- it is assumed that the heavy water was delivered in a few batches with 99.0 % average molar percent of the D_2O and that the this purity was not changed sig-

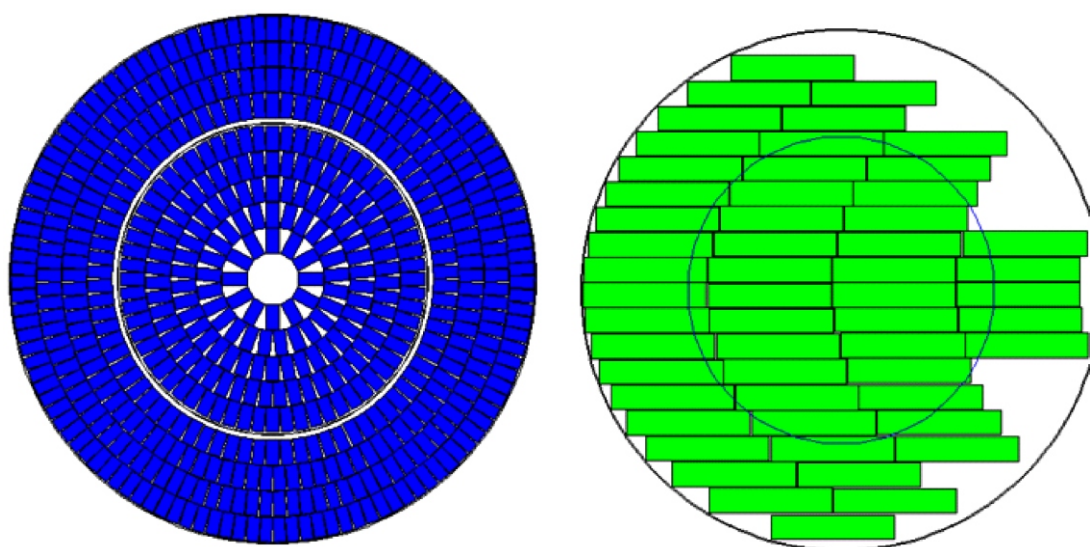

Figure 9. Sketches of the possible graphite reflectors designs made of the 5 cm 10 cm 50 cm prefabricated graphite blocks (inner circle shows diameter of the Mg tank and outer circle shows diameter of the Al tank)

- nificantly during normal handling and transportation of the D₂O moderator;
- the maximum level of the D₂O moderator in the U-D₂O core is assumed to 119.8 cm, which corresponds to exact amount of 1.5 t of the D₂O moderator;
- mass density of natural graphite (with equivalent EBC of 4.212 ppm) is 1.7 gcm⁻³ in the radial reflector (without gaps), and 1.58 gcm⁻³ in the top and bottom GR to account for (about 7 %) volume of the air gaps (assumed homogeneously distributed) in graphite [20];
- a cylindrical air gap, thick 2.7 cm, exists between the Mg tank outer wall and surface of the radial GR (thick 40 cm);
- sealing of the Mg and Al tanks is modeled with the top SS disk (211 cm diameter and 1.0 cm thick) and two AZ91D (62.0 cm radius) disks placed at the top (0.7 cm thick) and bottom (1.0 cm thick) of the top GR (39 cm thick) at the top of the Mg tank.

The vertical cross section (along diameter) of the B-VIII 3-D upgraded model is shown at the left in fig. 10 together with a version (at the right) which includes modeling the central chimney and six vertical experimental tubes. Zones of the B-VIII 3-D model at the right side of fig. 10 have the same materials as at the left side version of fig. 10. Positions, material, dimensions and number of the experimental tubes are unknown and are modeled according to the B-VIII sketch shown in fig. 2. Dimensions and material of the chimney and experimental tubes are chosen by the author of this article according to his experimental experience. The material of the chimney is modeled of the 5051A (or 1100) Al alloy or AZ91D Mg alloy. Assumed dimensions of the chimney are: tube diameter of 5.0 cm and wall thickness of 1 mm. Six experimental tubes are modeled with the same material as the

chimney, with 1 mm wall thickness and 2.0 cm tube diameter. The closed bottoms (1 mm thick) of the experimental tubes are assumed to exist below the radial mid-plane of the U-D₂O core, at 54.0 cm above the bottom of the Mg tank. The inner space of the chimney and the experimental tubes is filled with the air, *i. e.*, without any experimental probes and the probe's support material. It is also assumed that there are no Cd control rods inserted in the B-VIII system. Any variation of this B-VIII 3-D upgraded model will be explained below tab. 4, which includes only a small number of many calculation results.

CALCULATION RESULTS AND DISCUSSION

Fuel cell infinite multiplication factor

To evaluate the B-VIII possibility to make self-sustainable fission reactions in a reactor lattice, the neutron infinite multiplication factor (k_{∞}) in the "infinite" media is calculated for the fuel cell (section *B-VIII fuel cell model* of previous chapter). This is done with the MCNP6.1 code applied to the neutron transport and continuous-energy neutron cross sections from the ACE type endf71 data library, at temperature of 293.6 K. Neutron scattering effects in neutron thermal energy range on: (a) the deuterium and hydrogen atoms bounded in the D₂O, or H₂O molecules and (b) the carbon atoms in the graphite, are included applying ACE type endf71Sab thermal neutron scattering library at 293.16 K. The temperature of the D₂O moderator in the fuel cell is assumed at 20 °C. The materials of the 'ideal purity' (100 % pure nUm, 100 % mol pure D₂O and 100 % pure Al), with theoretical data taken from [36-37], are used for these cases.

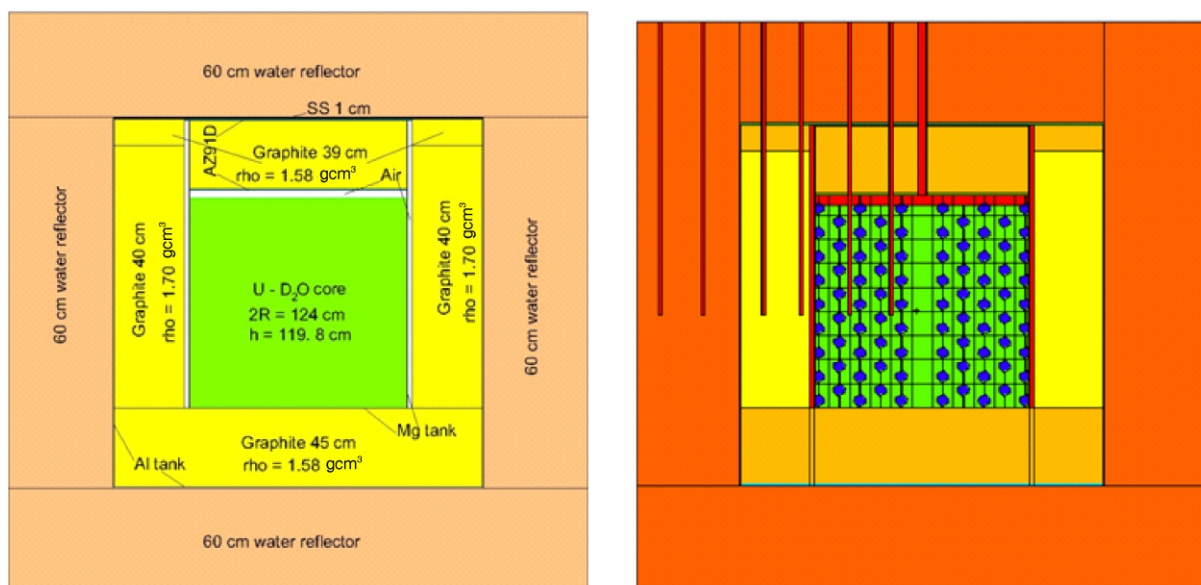

Figure 10. B-VIII 3-D upgraded model

The infinite media is simulated in the MCNP6.1 code by setting the periodic (or reflector) boundaries at side surfaces of the fuel cell. The code is run for two million (active) neutron histories (2 Mnh) in the neutron transport mode (MODE N, KCODE) which provided the relative (statistical standard deviation, 1σ) uncertainty of 0.00025. This uncertainty of the calculation results is considered as acceptable since the measured neutron multiplication factor in the B-VIII, done by German scientists in March-April 1945, was reported at $M=6.7$, without any uncertainty. From this reported experimental value of the neutron multiplication factor, it was simply deduced that the B-VIII was a deeply subcritical system, since the value $k_{\text{eff}} = k$ was calculated to 0.85075, *i. e.*, almost 15 000 pcm ($1 \text{ pcm} = 1.0 \cdot 10^{-5} \Delta k/k$) below the critical value (1.0).

MCNP6.1 calculations are done for the Vertex model of the nUm cubes in the fuel cell of the square lattice. Because the nUm cubes were assumed to be completely immersed in D₂O moderator in the B-VIII, *i. e.*, all faces of the cube were covered by the moderator, the orientation of the nUm cube (*i. e.*, the 'hanging mode') has no significant effect on neutron transport and multiplication in the fuel cell. The results of the calculated $k_{\infty} = k_{\text{inf}}$ in function of the square lattice pitch (a) are shown in fig. 11. The fig. 11 shows that, if the square lattice pitch (a) is changing in the range of 9 cm to 21 cm, the value of the k_{inf} is increasing from 0.89994 ± 0.00024 to 1.28134 ± 0.00025. The calculated value of the k_{inf} for the B-VIII assumed pitch ($a = 14 \text{ cm}$) is 1.21328 ± 0.00026, while for a square pitch of $a = 12.0 \text{ cm}$, $k_{\text{inf}} = 1.13969 \pm 0.00029$. Therefore, the B-VIII could become critical, in a case of "100 % pure materials", in both cases of the square pitches above mentioned, if the geometry arrangement ("geometry buckling") was such that neutron leakage from the system does not reduce the k_{eff} below 1.0. This conclusion is valid under assumption of the fuel cell complete symmetry (section *The simplifications*

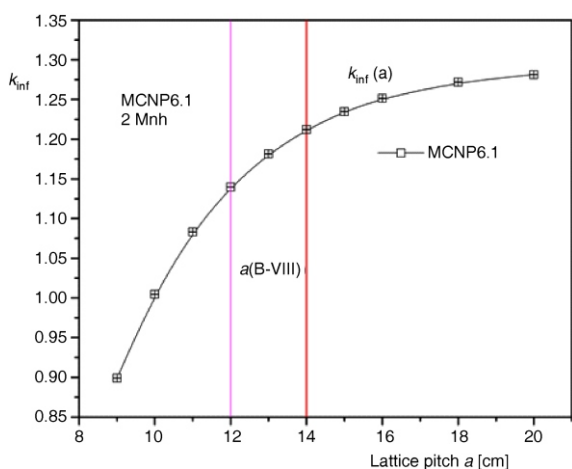

Figure 11. Infinite neutron multiplication factor (k_{inf}) in function of the square lattice pitch (a) of the B-VIII fuel cell

and assumptions of previous chapter) and suggests that German scientists were missing appropriate quantity of nuclear material and suitable geometry arrangements to achieve a critical fission system.

Another analysis of the B-VIII fuel cell shows dependence of the k_{inf} in function of the purity of D₂O moderator in the square lattice fuel cell with 14 cm pitch (fig. 12). MCNP6.1 calculations are done for the Vertex model of the nUm cube in the cell. The code is run for 2 Mnh in the neutron transport mode which provided the 1σ of 0.00025. The nUm is assumed with impurities equal to 5 ppm EBC. Only for the "100 % pure materials" case of (100 % mol) pure D₂O, the results of the calculations are also added by the result obtained for the 100 % pure nUm. When the molar percent of the D₂O in the D₂O moderator is changing in the range of 90 % to 100 %, the k_{inf} is changing from 0.96758 ± 0.00025 to 1.19957 ± 0.00025. The fig. 12 shows that the k_{inf} , in this case of the fuel cell, is higher than 1.0 (*i. e.*, the B-VIII could be critical) for the molar percent of the D₂O in the D₂O moderator higher than 92 % (assuming full fuel cell symmetry, section *The simplifications and assumptions* of previous chapter). It also may be concluded, from fig. 12, that reactivity (Δk_{inf}) of the infinite fuel cell decreases for about -2300 pcm per reduction of 1 % mol of D₂O.

Influence of the D₂O moderator temperature on the k_{inf} in the B-VIII fuel cell, with a pitch of 14 cm and the Vertex model of the nUm cube (with the impurities equal to 5 ppm EBC), is shown in fig. 13. The MCNP6.1 code is run for 20 Mnh in the neutron transport mode which provided the 1σ of 0.00008. When the D₂O moderator temperature is changing from 5 °C to 20 °C, the k_{inf} is changing, roughly, like a parabolic curve with the maximum (1.19973 ± 0.00008) achieved at the temperature of 17 °C. This observation is under question, since the calculated values of the k_{inf} are changing within the 1σ uncertainty of the calculation results. The lower relative statistical 1σ uncertainty

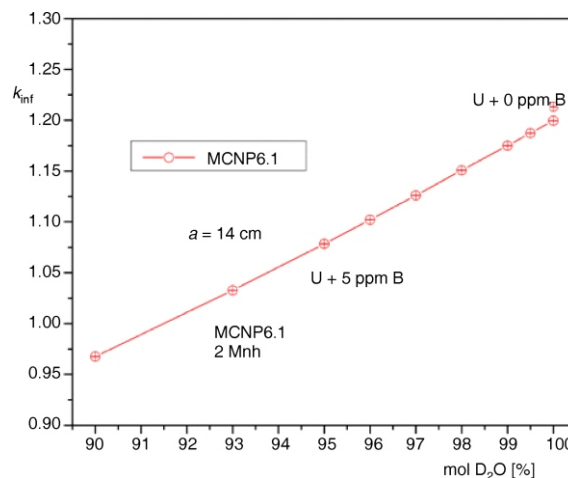

Figure 12. Neutron infinite multiplication factor (k_{inf}) in function of molar percent of D₂O in moderator of the B-VIII fuel cell with the square lattice pitch $a = 14 \text{ cm}$

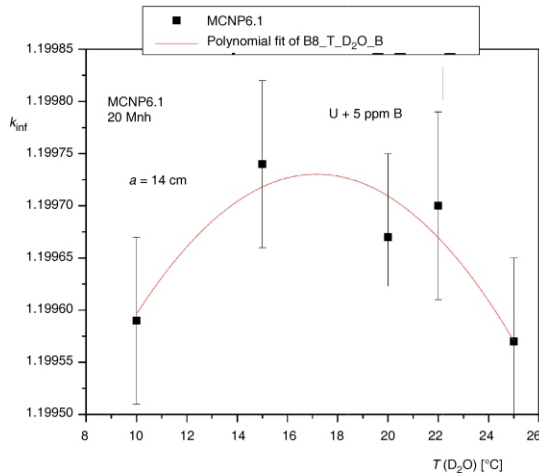

Figure 13. Neutron infinite multiplication factor (k_{inf}) in function of the D_2O moderator temperature (T) in the B-VIII fuel cell with the square lattice pitch $a = 14$ cm

could be achieved by increasing the number of neutron histories in the code run, what would require much longer clock time of the calculations. However, this result of change of the k_{∞} with the D_2O temperature, points out that exact temperature, at which the B-VIII was operated, had a negligible effect on the neutron effective multiplication factor (k_{eff}) of the facility, *i. e.*, on the neutron multiplication factor (M).

B-VIII 3-D simple model

Results of MCNP calculations for B-VIII 3-D simple model, for '100 % pure materials' are shown in tab. 1.

The calculation results for the "100 % pure materials" cases, shown in tab. 1, confirm the reactor theory prediction that orientation (E, V, F) of the nUm cubes fully immersed in the D_2O moderator of the fuel cell, has no importance, since the obtained values of the k_{eff} are within the 1σ uncertainty of the results. The calculation results also show that all selected lattices of the fuel cell with the "100 % pure materials" could form a critical system since the obtained values of the k_{eff} are, roughly, in the range of 1.009 to 1.014 in case of 40 cm thick bottom GR. The thickness of 50 cm of the bottom GR increases the values of the k_{eff} for (102–16) pcm, *i. e.*, the graphite thickness has a small effect on the k_{eff} . However, the "100 % pure materials" cases are not

practically feasible due to technological and economical constrains in the material production at an industrial scale, *i. e.*, there are no 100 % pure materials in large quantities. The impurities in "real materials" and reduced purity of the D_2O moderator would reduce this values of the k_{eff} for several hundreds or even thousands pcm. These results also show that attaining the criticality in the B-VIII fission system would be very unlikely with available quantities of the nuclear material in chosen geometry, as German scientists had estimated and concluded in their reports [18, 19].

Beside the cases with the 100 % pure materials in the 3-D simple model, the cases with materials containing impurities are investigated as well. MCNP6.1 calculations are done for the Edge model of the nUm cubes in the square lattice. The chosen content of impurities in the nUm is 5 ppm EBC, in the graphite (C)–10 ppm EBC, while purity of the heavy water moderator (at 20 °C) is 99 % mol D_2O , as the 'reference 3-D simple model'. The Mg tank and its cover are made of alloy AZ91D, the Al tank is made of alloy 5051A, while the Al wires are made of alloy 5025A. Neutron cross sections for all the solid materials and demineralized water (with natural content of the D_2O) are taken at 20 °C. The MCNP6.1 code is run for 10 Mnh in the neutron transport mode, which provided the 1σ of 0.00017. The calculated k_{eff} for this 'reference 3-D simple model' is 0.95405 ± 0.00018, which is far above expected one (0.851).

The variation of the EBC of content of impurities is done in the range of 1 ppm to 20 ppm for the nUm, keeping the content impurities in the graphite at 10 ppm EBC and the D_2O moderator purity at 99 % mol D_2O . The selected variations of the EBC of content of impurities in the graphite are 4.212 ppm EBC (natural graphite [25]) and 10(5)20 ppm EBC, keeping the EBC of impurities in the nUm at 5 ppm and the D_2O moderator purity at 99 % mol D_2O . The nuclear grade graphite with 1 ppm EBC is selected, as well, for these variations. Results of the calculations are shown in tab. 2 and fig. 14. Effect of the purity of the D_2O moderator was examined also using the reference 3-D simple model. The contents of the impurities of 5 ppm EBC in the natural U metal and 10 ppm EBC in the graphite are kept constant, while variation of the D_2O moderator purity is covering the range of 89(2)99 % mol D_2O . Results of these calculations are shown in tab. 3 and fig. 15.

Table 1. MCNP6.1 calculated neutron effective multiplication factor (k_{eff} ± 1σ) for the 3-D simple model of the B-VIII

Materials	100 % pure											
	40 cm thick						50 cm thick					
	Lattice model			Lattice model			Lattice model			Lattice model		
nUm cube model	Square	Hexagonal	LIN-circular	Square	Hexagonal	LIN-circular	Square	Hexagonal	LIN-circular	Square	Hexagonal	LIN-circular
Edge (E)	1.00863	0.00016	1.01081	0.00016	1.01383	0.00016	1.00983	0.00016	1.01169	0.00016	1.01481	0.00016
Vertex (V)	1.00878	0.00016	1.01085	0.00016	1.01369	0.00016	1.00990	0.00017	1.01184	0.00016	1.01462	0.00016
Face (F)	1.00879	0.00016	1.01075	0.00016	1.01390	0.00016	1.00996	0.00016	1.01198	0.00016	1.01470	0.00016

Table 2. MCNP6.1 calculated neutron effective multiplication factor k_{eff} 1σ for influence of impurities in natural uranium metal and graphite in the 3-D simple model of the B-VIII (99 % mol D₂O at 20 °C)

Impurities (ppm EBC) in nUm for 10 ppm EBC impurities in graphite	k_{eff} 1σ	Impurities (ppm EBC) in graphite for 5 ppm EBC impurities in nUm	k_{eff} 1σ
1	0.96154 0.00017	1 (nuclear grade)	0.97127 0.00016
5	0.95405 0.00018	4.212 (natural)	0.96418 0.00016
10	0.94508 0.00017	10	0.95405 0.00018
15	0.93599 0.00016	15	0.94732 0.00017
20	0.92808 0.00017	20	0.94199 0.00017

Table 3. MCNP6.1 calculated neutron effective multiplication factor $k_{eff} \pm 1\sigma$ for the purity of the D₂O moderator (at 20 °C) in the 3-D simple model of the B-VIII (nUm + 5 ppm EBC and graphite + 10 ppm EBC)

Purity of D ₂ O moderator (% mol D ₂ O)	k_{eff} 1σ
89.0	0.85496 0.00015
91.0	0.87756 0.00015
93.0	0.89893 0.00015
95.0	0.91968 0.00015
97.0	0.93823 0.00016
99.0	0.95405 0.00018

From results of the calculations, shown in tab. 2 and fig. 14, we may conclude that the reactivity ($\Delta k/k$) of the B-VIII decreases about -175 pcm per increase of 1 ppm EBC of the impurity content in the nUm and about -150 pcm per increase of 1 ppm EBC of the impurity content in the graphite. Results of the calculations given in tab. 3 and fig. 15, show that reactivity ($\Delta k/k$) of the B-VIII decreases for about -1000 pcm per decrease of 1 % mol D₂O purity, *i. e.*, the purity of D₂O has the major effect on k_{eff} of the B-VIII.

The tabs. 2 and 3 and figs. 14 and 15 show that the values of calculated $k_{eff} \pm 1\sigma$ provide values of the neutron multiplications factors M which are still far away from the expected one (0.851) indicating that, if the measurement result was truthful, the materials and dimensions used in the B-VIII simple modeling are not correct, due to different reasons, and should be upgraded, if possible, as it was tried in the next section.

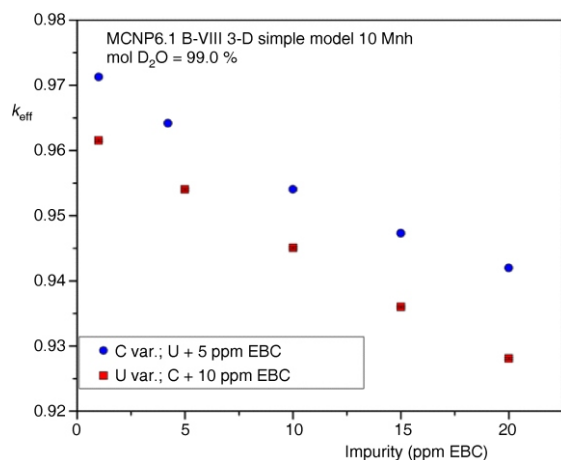

Figure 14. Calculated effect of impurities in natural uranium metal and graphite on k_{eff} for B-VIII simple 3-D model

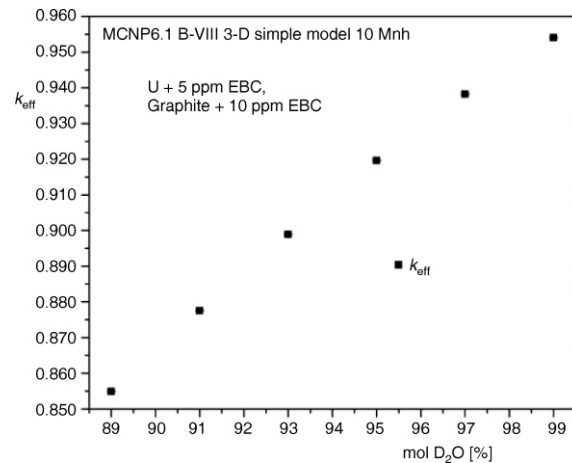

Figure 15. Calculated effects of D₂O purity on k_{eff} for B-VIII simple 3-D model

B-VIII 3-D upgraded model

To evaluate the B-VIII criticality, the 3-D upgraded model is used to determine the k_{eff} in the system. This is done with the same computation tools mentioned in section *Fuel cell infinite multiplication factor* of this chapter. The temperature of the D₂O moderator in the B-VIII core is assumed at 20 °C. The materials explained in previous sections are used and briefly noted in tab. 4. The cases labeled with initial capital A cover the non-flooded system, while ones with initial capital H cover the H₂O flooded system. Any variation of this B-VIII 3-D upgraded model, or computation tools, is explained below for particular option (case) of the modeling. The MCNP6.1 code is run for 10 Mnh in the neutron transport mode which provided the 1σ of 0.00017 and the results are given in tab. 4.

Cases A4, A6, and A7 show calculation results for the neutron multiplication at the B-VIII 3-D upgraded model obtained under assumption that all graphite and the water reflectors are replaced with air, *i. e.*, for the U-D₂O unreflected and unshielded core in the Mg tank.

Cases A12L, A14L, and A16L show MCNP6.1 calculation results with materials used by LIN research group and obtained for the B-VIII 3D upgraded model. Case A12L uses the nUm cubes in the U-Al chains, instead the fuel lumped rods (cases A14L and A16L),

Table 4. MCNP6.1 calculated neutron effective multiplication factor and neutron multiplication factor for the B-VIII 3-D upgraded model

Case	nUm form, ρ [gcm^{-3}] & EBC [ppm]	D ₂ O [mol %]	U-D ₂ O lattice & nUm model	Nat. Graphite reflectors ρ [gcm^{-3}] & EBC [ppm]	Air or H ₂ O in gaps in Al tank	Chimney & six experimental tubes	k_{eff} 1	M 1
A1	cubes, $\rho = 19.05$, EBC = 7.0	99.0	Square, Edge	$\rho = 1.70$, EBC = 4.212	Air	No	0.95310 0.00017	21.32 0.08
A4	cubes, $\rho = 19.05$, EBC = 7.0	95.0	Square, Edge	Air ^(a)	Air	No	0.82675 0.00017	5.77 0.01
A5	cubes, $\rho = 19.05$, EBC = 7.0	95.0	Square, Edge	$\rho = 1.58$, EBC = 4.212	Air	No	0.91405 0.00016	11.64 0.02
A6	cubes, $\rho = 19.05$, EBC = 7.0	95.0	Square, Edge	Air ^(b)	Air	No	0.81166 0.00018	5.31 0.01
A7	cubes, $\rho = 19.05$, EBC = 7.0	99.0	Square, Edge	Air ^(b)	Air	No	0.81036 0.00019	5.27 0.01
A10	cubes, $\rho = 19.05$, EBC = 7.0	99.0	Square, Edge	$\rho = 1.70$, EBC = 4.212	Air	Al 5051A	0.95053 0.00016	20.21 0.07
A11	cubes, $\rho = 19.05$, EBC = 7.0	99.0	Square, Edge	$\rho = 1.70$, EBC = 4.212	Air	No	0.95109 0.00017	20.45 0.07
A12L ^(e)	cubes, $\rho = 19.05$, EBC = 7.0	95.0	LIN, Vertex	$\rho = 1.80$, EBC = 4.212	Air	No	0.93160 0.00016	14.62 0.03
A14L ^(c)	LIN lumped rod	95.0	LIN, Vertex	$\rho = 1.80$, EBC = 4.212	Air	No	0.85930 0.00018	7.11 0.01
A15	cubes, $\rho = 19.05$, EBC = 7.0	99.0	Square, Edge	$\rho = 1.70$ & 1.58 (7% air) EBC = 4.212	Air	No	0.93775 0.00017	16.06 0.01
A16L ^(d)	LIN lumped rod	95.0	LIN, Vertex	$\rho = 1.80$, EBC = 4.212	Air	No	0.85830 0.00018	7.06 0.01
A17 ^(e)	cubes, $\rho = 19.05$, EBC = 7.0	94.0	Square, Edge	$\rho = 1.70$ & 1.58 (7% air) EBC = 4.212	Air	Al 5051A	0.90221 0.00016	10.23 0.02
A18 ^(e)	cubes, $\rho = 19.05$, EBC = 7.0	90.0	Square, Edge	$\rho = 1.70$ & 1.58 (7% air) EBC = 4.212	Air	Al 5051A	0.86509 0.00015	7.41 0.01
A19 ^(e)	cubes, $\rho = 19.05$, EBC = 7.0	88.0	Square, Edge	$\rho = 1.70$ & 1.58 (7% air) EBC = 4.212	Air	Al 5051A	0.84499 0.00016	6.45 0.01
A20j ^(g)	cubes, $\rho = 19.05$, EBC = 7.0	88.0	Square, Edge	$\rho = 1.70$ & 1.58 (7% air) EBC = 4.212	Air	Al 5051A	0.84478 0.00015	6.44 0.01
A21x	cubes, $\rho = 19.05$, EBC = 7.0	88.0	Hexagonal, Edge	$\rho = 1.70$ & 1.58 (7% air) EBC = 4.212	Air	Al 5051A	0.83953 0.00015	6.23 0.01
A22L	cubes, $\rho = 19.05$, EBC = 7.0	88.0	LIN, Vertex	$\rho = 1.70$ & 1.58 (7% air) EBC = 4.212	Air	Al 5051A	0.85106 0.00015	6.71 0.01
A23	cubes, $\rho = 19.05$, EBC = 7.0	88.0	LIN, Vertex	$\rho = 1.70$ & 1.58 (7% air) EBC = 4.212	Air	Al 5051A	0.84530 0.00016	6.46 0.01
H7	cubes, $\rho = 19.05$, EBC = 7.0	96.0	Square, Edge	$\rho = 1.70$ & 1.65 (7% H ₂ O) EBC = 4.212	H ₂ O	No	0.89595 0.00015	9.61 0.01
H8 ^(f)	cubes, $\rho = 19.05$, EBC = 7.0	96.0	Square, Edge	$\rho = 1.7$ & 1.65 (7% H ₂ O) EBC = 4.212	H ₂ O	Al 5051A	0.89596 0.00015	9.61 0.01
H9 ^(f)	cubes, $\rho = 19.05$, EBC = 7.0	92.0	Square, Edge	$\rho = 1.70$ & 1.65 (7% H ₂ O) EBC = 4.212	H ₂ O	Al 5051A	0.86595 0.00015	7.46 0.01
H10 ^(f)	cubes, $\rho = 19.05$, EBC = 7.0	90.0	Square, Edge	$\rho = 1.70$ & 1.65 (7% H ₂ O) EBC = 4.212	H ₂ O	Al 5051A	0.84864 0.00015	6.61 0.01
H11j ^(g)	cubes, $\rho = 19.05$, EBC = 7.0	90.0	Square, Edge	$\rho = 1.70$ & 1.65 (7% H ₂ O) EBC = 4.212	H ₂ O	Al 5051A	0.84911 0.00015	6.63 0.01
H12x	cubes, $\rho = 19.05$, EBC = 7.0	90.0	Hexagonal, Edge	$\rho = 1.70$ & 1.65 (7% H ₂ O) EBC = 4.212	H ₂ O	Al 5051A	0.84137 0.00015	6.30 0.01
H13L	cubes, $\rho = 19.05$, EBC = 7.0	90.0	LIN, Vertex	$\rho = 1.70$ & 1.65 (7% H ₂ O) EBC = 4.212	H ₂ O	Al 5051A	0.85344 0.00015	6.28 0.01

Notes: (a) all graphite replaced by air; (b) all graphite and H₂O replaced by air; (c) LIN materials, MCNP5 and LIN selected neutron data library; (d) LIN materials, MCNP6.1 and endf71 neutron data library; (e) estimated purity of the heavy water moderator for the measured multiplication factor; no flooding of the U-D₂O core in the Al and Mg tanks; endf71 neutron data library; (f) estimated purity of the heavy water moderator for the measured multiplication factor; flooding of the U-D₂O core in the Mg tank and in the Al tank with H₂O from the water reflector; (g) MCNP6.1 with jeff3.2 neutron data library.

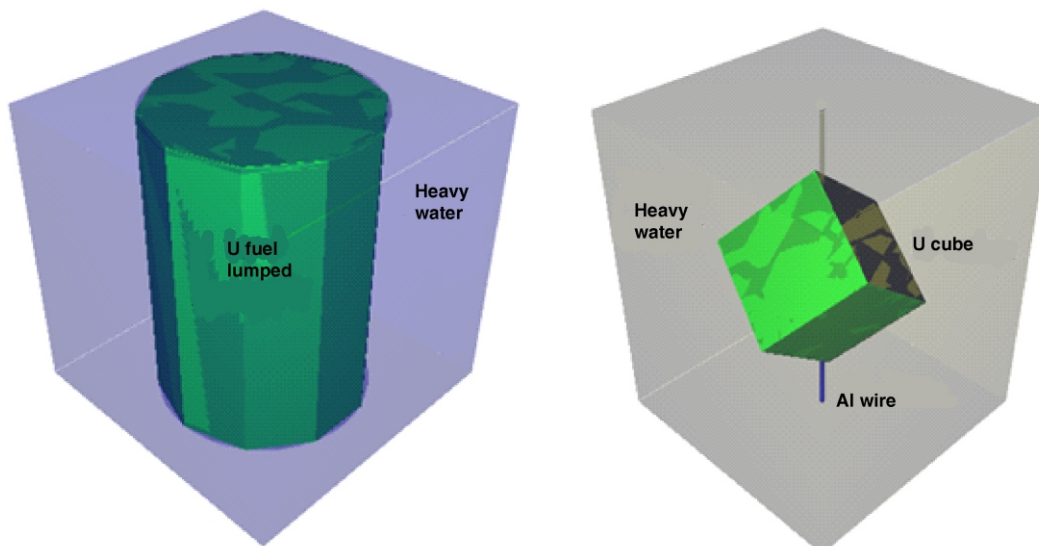

Figure 16. LIN fuel cell ($a = 11.5$ cm) for lumped fuel rods (left) and heterogeneous (cube) fuel (right)

used in the article [25] prepared by the LIN research group. The results (A14L and A16L), obtained using MCNP5 or MCNP6.1 versions of the code for k_{eff} , are very close to the one reported for the 'Model C' (the reflector from the natural graphite with mass density of 1.8 gcm^{-3}) in [25]: 0.85748 ± 0.00013 . Comparing the results of the A12L case with the A14L or A16L cases, we may conclude that a relatively large difference (about 6 000 pcm) in k_{eff} is the consequence of using lumped fuel rods in [25] instead of the real fuel geometry (cubes). The MCNP6.1 calculation gives the k_{∞} for the of B-VIII fuel cell of a square ($a = 11.5$ cm) lattice with lumped fuel rods and 95 % D_2O (shown in fig. 16 left), a value $k_{\infty} = 0.96762 \pm 0.00034$. This value of the k_{∞} is far below the one obtained for the same lattice pitch with the fuel cell with the Vertex model of the nUm cube with Al 5025A wires and 95 % D_2O , shown in fig. 16 (right): $k_{\infty} = 1.09670 \pm 0.00024$.

The LIN lumped fuel parameters were calculated using mass fractions of the material component in the fuel homogeneous cylindrical rod with equivalent diameter equal to $10/(3/\sqrt{6})$ cm [25], which increased the surface for interaction to the D_2O moderator of the equivalent fuel rod about 2.5 times compared to the surface of the nUm cubes. That homogenization had a consequence in change of the neutron resonant absorption and self-shielding effect in the nUm (thick) fuel and, therefore, made a difference in the calculated k_{eff} compared to the real fuel-geometry used in B-VIII 3-D upgraded model.

Cases from A17 to A19 show the influence of the D_2O moderator initial purity on the criticality of the B-VIII. They demonstrate that the purity of about 88 % molar of the D_2O moderator is the one which gives the calculation result of the MCNP6.1 almost

equal to the experimental multiplication factor. The assumptions used are as follows:

- the hermetically sealed Al and Mg tanks, *i. e.*, air zones exist in these tanks,
- all nUm cubes have composition determined in [38] and mass density of 19.05 gcm^{-3} ,
- total amount (exactly 1.5 t) of D_2O was inserted in the Mg tank, and
- the natural graphite was used with the mass density of 1.7 gcm^{-3} in radial GR, and 1.58 gcm^{-3} in the top and bottom GR.

Comparing the cases A10 and A11 we may conclude that the calculated reactivity of $-(58.9 \pm 23.3)$ pcm, of the chimney and six experimental tubes, is about the value (-35 pcm) , assumed by the LIN research group. However, the MCNP6.1 calculation results shows, comparing the cases H7 and H8 in cases of the flooded Al and Mg tanks with water, that the experimental tubes and chimney have a negligible reactivity in the system. The case A23 is the same as A19, but the SS material is replaced by Al 5051A alloy and value of the reactivity change of (37 ± 23) pcm between two cases indicated that the composition of this material in the B-VIII model has a very small effect on k_{eff} .

The low value (88 % mol) of purity of the D_2O moderator, required to reproduce the experimental result for neutron multiplication in B-VIII reported by German scientists, in the calculations done by MCNP code, deserves an attention and a brief study. This low value of the purity of the D_2O moderator could be consequence of (1) the total amount of D_2O moderator was distributed from the producer with such initial purity value; (2) mixing the D_2O moderators from several batches of different purity; (3) careless handling of the D_2O moderators during usage (in several designed facilities) and transportations; (4) partially or

total breaching of the top metal cover, used for sealing the Al and Mg tanks; or (5) any combination of the events mentioned in cases from (2) to (4). The first possibility will not be discussed, since it is a speculation of the initial molar purity of the D₂O moderator, in spite that the references [40-42] show the initial purity of about 99 % mol D₂O. Second case is the most probable. Third case is possible, but not so likely. In the 4th mentioned case, the H₂O from the water reflector could have penetrated into the Al and Mg tanks and overflowed the air gaps above the D₂O moderator in the Mg tank and in the Al tank with the GR. Such a case (H7) was supposed assuming that the H₂O from the water reflector had instantaneously filled all the air gaps in the Al tank and the air space (thick 4.21 cm) above maximum height of the D₂O moderator (determined for 1.5 t) in the Mg tank. The air gaps (7 % volume fraction), homogeneously distributed in the top and bottom GR, are filled with water and an equivalent average mass density of graphite-H₂O mixture in these GR has a calculated value of 1.65 gcm⁻³. An amount of the H₂O had mixed with the D₂O moderator (under assumption that their volumes in the Mg tank are conserved), and consequently, had reduced the D₂O moderator purity. It was also assumed that the D₂O moderator could not exit from the Mg tank and mix with H₂O in the Al tank, or in the water reflector. Simple molar calculations would show that, if the original molar purity of the D₂O moderator was 99.0 %, such amount (about 4.21 cm × × 62.0² cm² = 50 840 cm³) of H₂O and instantly mixed with D₂O moderator (about 1 446 620 cm³ for exactly 1.5 t), would reduce the purity of the D₂O moderator in the Mg tank to about 96 % mol. Possible earlier mixing (during slow process of approaching to criticality) would have caused very slow leaking of the H₂O in the Mg tank and have significantly reduced the purity of the D₂O moderator. Slow H₂O-D₂O mixing would have a consequence that the total amount (1.5 t) of the D₂O moderator could not be finally inserted in the Mg tank, what was not mentioned in the reports of German scientists. Furthermore, a low purity of the D₂O moderator may be a consequence of smaller total amount (less than 1.5 t) of D₂O moderator and mixing with H₂O during supposed flooding.

Cases from H8 to H10 show the influence of the D₂O moderator purity on the criticality of the B-VIII in case of the flooding the Al and Mg tanks. They demonstrate that the purity of about 90 % molar of the D₂O moderator is the one which provides that the MCNP6.1 calculation result is almost equal to the experimental value of the neutron multiplication factor.

Cases A20j and H11j show MCNP6.1 calculation results obtained for A19 and H10 case, with the

square lattice and the nUm cubes Edge model, respectively, but using the jeff3.2 neutron data library [52]. We may conclude that both the libraries (endf71 and jeff32) show almost the same result for the k_{eff} of the B-VIII, *i. e.* a difference is within the 1 σ relative uncertainty of the calculations. Cases A21x and H12x show MCNP6.1 calculation results obtained for the hexagonal lattice cases (with the nUm cubes Edge model), respectively, and the endf71 neutron data library. Cases A22L and H13L show MCNP6.1 calculation results obtained for the LIN circular-uniform lattice cases (with the nUm cubes Vertex model) and the endf71 neutron data library. We may conclude that all, above mentioned, similar cases (the air gaps filled by air or flooded by H₂O) show almost the same result for the k_{eff} of the B-VIII, *i. e.*, the difference is within the 1 σ relative uncertainty of the calculations.

The experimental result of the German scientists for the neutron multiplication factor M (6.7) was reported [17-19] as the quotient of (measured) average numbers of neutron population in the final stage (113.4) and average number of neutron population in the initial stage (16.9) in the process of approaching criticality of the B-VIII. We may assume, due to decimal numbers reported, that the experimental values were obtained as the average numbers after a (large) number of statistical measurements of counting from the activity of the neutron sensitive probes (Dy) and that Gauss distribution was satisfied. If the other statistical and systematical uncertainties were not included, the average values of the counts allow us to estimate the standard deviation of the average number of the counts as a square root of the average number of neutrons [47] and to estimate uncertainty (equal to the standard deviation, *i. e.*, 1 σ) of the M as 1.75. Therefore, it may be believed that the experimental result of the neutron multiplication M (6.71) was (roughly) between 4.96 and 8.46, with a probability of about 67 %.

It is also assumed that the value of the experimental neutron multiplication factor was obtained after measurements in which the fundamental mode of neutron flux density in the B-VIII has achieved (in time domain) the asymptotic, *i. e.*, saturation, level [47, 48]. This assumption is required for the validity of a proportion of the neutron flux density and the neutron multiplication in the subcritical system with an external neutron source. Furthermore, it is expected that experimental measurements of the neutron population in the B-VIII were done, at reported levels of D₂O with the external neutron source, after all necessary corrections were applied to obtain activity of used neutron probes. These corrections include location of the probes, the probe's sizes and masses, times of irradiation, cooling and activity measurements and background counts measurements.

CONCLUSIONS

This paper is a new approach to the neutronics study of the B-VIII reactor, with an attempt to model real geometry of fuel-moderator interaction and use the best data for the geometry and materials of the system. This study points out many approximations and simplifications, made during modeling of the B-VIII material composition and geometry, as consequences of missing or inconsistent data. The paper also tries to investigate and show the influences to criticality of numerous uncertainties in the material compositions, mass densities and geometry of the facility. The Monte Carlo MCNP6.1 code and the ACE type neutron nuclear cross section data from endf71 are used for that purpose. Additionally, an attempt of estimation of the uncertainty of the experimental result of the neutron multiplication, was given. Differences in the calculated values of the neutron multiplication and the experimental one are investigated and tried to explain. Some possible reasons for the calculated low value of the purity of the heavy water moderator are given and analyzed. Therefore, results of the water flooded the U-D₂O core and the graphite reflectors of the B-VIII, as a possible source of the D₂O moderator reduced purity, are shown too. Analyses are done for three assumed fuel lattice types and three models of space orientations of the nUm cubes hanging on the Al wires. It was shown that the major influence to criticality of the B-VIII reactor had the purity of the heavy water moderator, assuming that most of the geometry and material data (especially for the composition of the nUm cubes, the core geometry and the graphite reflectors) were given correctly in the German reports and published articles. The analyses confirm that the B-VIII was a subcritical device, as it was shown by the experimental result of the German scientists done in spring 1945 at Haigerloch, *i. e.* the criticality was not achieved in the B-VIII reactor of reported design. However, the analyses in this study, done on the B-VIII model, indicate that the B-VIII reactor was not so deeply subcritical, as it was shown by the experimental result [17-19] of the German scientists. The analyses also confirm a conclusion derived by German scientists that they had not enough quantity of the nuclear material and had not achieved proper geometry arrangement to make the B-VIII a critical fission system.

ACKNOWLEDGEMENTS

The author owes his deeply gratitude to Ms. Dr. Andrea Hohmeyer, Head of the Corp. Archives of Evronik Industries AG, Hanau-Wolfgang, Germany, and to Ms. Dr. Maria Wallenius, at EU JRC Directorate for Nuclear Safety and Security, Department for Nuclear Security and Safeguards, Nuclear Safeguards and Forensics Unit, Karlsruhe, Germany, for their kindness and the information provided.

ABBREVIATIONS AND NON-SI UNITS

KWI	– Kaiser-Wilhelm (now Max Planck) Institute, Berlin
nUm	– natural uranium metal
GR	– graphite reflector
EBC	– equivalent boron content
SS	– stainless steel
WWII	– World War II
Mnh	– million neutron histories
NCCP	– Novosibirsk Chemical Concentrates Plant
ICP-MS	– inductively coupled plasma mass spectroscopy
1σ	– relative statistical uncertainty (standard deviation) of MCNP calculation
k_{eff}	– neutron effective multiplication factor
k_{∞}	– neutron infinite multiplication factor (k_{inf})
M	– neutron multiplication factor in a subcritical system with external neutron source
ρ	– mass density, [gcm^{-3}]
σ_0 (σ_{tot})	– neutron total cross section (b) at 2200 ms^{-1}
σ_c	– neutron capture cross section (b) at 2200 ms^{-1}
σ_a	– neutron absorption cross section (b) at 2200 ms^{-1}
σ_s	– neutron scattering cross section (b) at 2200 ms^{-1}
b	– barn ($1 \cdot 10^{-24} \text{ cm}^2$)
pcm	– reactivity equal to $1 \cdot 10^{-5} \Delta k/k$
ppm	– $1 \cdot 10^{-6} \text{ gg}^{-1}$ (1.0 gg^{-1})

Appendix 1

Table A1. Content of metallic impurities in the natural uranium metal cube sample [38] (ICP-MS, relative uncertainty 12 %)

Element	Weight fraction [ppm] ^(b)	Element	Weight fraction [ppm]
Al	602	Mo	2.0
As	1.3	Na	74
Ba	6.3	Ni	98
Be	1.5	P	24.5
Ca	30	Pb	250
Ce	1.3	Si	418
Co	1.6	Sn	3.2
Cr	29	Ti	24
Cu	15	V	2.9
Fe	1680	W	9.6
K	31	Zn	8.4
Mg	2.7	Zr	6.6
Mn	43	U	Rest ^(a)

Note: (a) U weight fraction is calculated as a balance

(b) 1 ppm = gg^{-1} of U

REFERENCES

- [1] ***, Heisenberg Interview given to the Spiegel Magazine: Spiegel, No 28, Dec. 03 1967. <http://werner-heisenberg.unh.edu/spiegel.htm>, (1967), also <https://>

- www.haigerloch.de/de/Tourismus/Atomkellermuseum/Interview-Heisenberg-%28engl.%29
- [2] Bethe, H. A., The German Uranium Project, *Physics Today*, 53 (2000), 7, pp. 34-36
- [3] Bothe, W., Jensen, P., Die Absorption thermischer Neutronen in Kohlestoff, *Z. Phys.*, 122 (1944), pp. 749-755
- [4] Irving, D., The Virus House, Germany's Atomic Research and Allies Counter-Measures, Focal Point, Perforce UK Ltd., 2002
- [5] Macrakis, K., Surviving the Swastika – Scientific Research in Nazi Germany, Oxford University Press, New York, 1993
- [6] Kant, H., Werner Heisenberg and German Uranium Project, (in German) Preprint 203, pp. 1-21, Max-Planck Institut für Wissenschaftsgeschichte, Göttingen, Germany, 2002, Paper Presented on a conference in Moscow (November 13/14, 2001) at the Institute for the History of Science and Technology
- [7] Iojrish, A., *et al.*, A-Bomb, Academy of Science USSR, Institute of Management and Law, "Science" Publisher, Moscow, USSR, 1980
- [8] Walker, M., Nazi Science, Myth, Truth and German Atomic Bomb, Perseus Publ. Cambridge, MA, USA, 1995
- [9] Rose, P. L., Heisenberg and the Nazi Atomic Bomb Project, A Study in German Culture, University of California Press, Cal., USA, 1998
- [10] Rudho, G., Xhixho, B., Heisenberg and the German Nuclear Research Project, Project JDF IQP 0712, Faculty of Worcester Polytechnic Institute, Mass., USA March, 2004
- [11] Hoffmann, D., Zwischen Autonomie und Anpassung: Die Deutsche Physikalische Gesellschaft im Dritten Reich, Max Planck Institute for the History of Science, Preprint 192, 2001
- [12] Amacher, J., The Nazi Bomb, Failures of the German Nuclear Program, <http://www.history.ucsb.edu/projects/holocaust/research/proseminar/johnamacher.htm>
- [13] Klotz, I. M., Captives of Their Fantasies: The German Atomic Bomb Scientists, *Journal of Chemical Education*, 74 (1997), 2, pp. 204-209
- [14] Walker, M., Eine Waffenschmiede? Kernwaffen- und Reaktorforschung für Physik am Kaiser-Wilhelm-Institut, Ergebnisse 26, Vorabdrucke aus dem Forschungsprogramm „Geschichte der Kaiser-Wilhelm-Gesellschaft im Nationalsozialismus“, Berlin 2005
- [15] ***, Ee Publishers: The German Nuclear Programme of World War Two, part 1 & 2, 2016, <http://www.ee.co.za/article/german-nuclear-programme-world-war-two-part-1.html>
- [16] Thomson, J., Nazi Nuclear Research: Why didn't Hitler get the Bomb?, a Power Point Presentation at www.safetyengineering.com.
- [17] Heisenberg, W., Wirtz, K., Grossversuche zur Vorbereitung der Konstruktion eines Uranbrenners, Max-Planck Institut für Physik, Göttingen, Extract from *Naturforschung und Medizin in Deutschland 1939-1946*, Band 14: Kernphysik und Kosmische Strahlen, Teil II, Section 7.1, pp. 143-165, Verlag Chemie GmbH, Weinheim/Bergstr, 1947
- [18] ***, FIAT Review of German Science 1939-1946, Part II, Nuclear Physics and Cosmic Rays (Wiesbaden: Dieterich'sche Verlagsbuchhandlung for Office of Military Government for Germany Field Information Agencies Technical – FIAT, 1948); Partly reprinted in [21], 2003, pp. 43-65*
- [19] Bopp, F., *et al.*, Bericht über den Versuch B8 in Haigerloch, Forschungsbericht 1945, Unveröffentlicht, 1946
- [20] Bopp, F., *et al.*, Bericht über einen Versuch mit $1,5$ t D_2O und U und 40 cm Kohlerücktreumantel (B 7), Bb-Nr. 1/45 gKdos, Seite 1-6, Kaiser-Wilhelm-Institut für Physik in Berlin-Dahlem (3.1.1945), in Digital Archive of Deutsches Museum, München, Germany, see [22]
- [21] Fechter, E., Humburg in der Höhlenforschungsstelle – zum Atomkeller Museum Haigerloch, EF Verlag, Mai 2003, pp. 1-239
- [22] ***, <http://www.deutsches-museum.de/archiv/archiv-online/geheimdokumente/>
- [23] Wirtz, K., Historisches zu den Uranarbeiten in Deutschland in den Jahren 1940-1945, *Physikalische Blätter*, vol. 11, 1947, pp. 371-379
- [24] JOOS, G.: Bericht äussert reiner Kohle [March 24, 1940] under "Forschungszentrum Berlin," in FÜSSL, W. AND KNAPP M., *Geheimdokumente zum deutschen Atomprogramm 1938-1945*, 2 pages, CD-ROM, Deutsches Museum, München, Germany, 2001
- [25] Grasso, G., *et al.*, A Neutronics Study of the 1945 Haigerloch B-VIII Nuclear Reactor, *Phys. Perspect.*, 11 (2009), pp. 318-335
- [26] Blumenthal, B., Melting of High Purity Uranium, *Transactions of AIME, Journal of Metals*, (1955), Nov., pp. 1199-2005
- [27] ***, Standard Practice for Determining Equivalent Boron Contents of Nuclear Materials, ASTM C1233-09, ASTM International, West Conshohocken, Penn., USA, 2009
- [28] X-5 Monte Carlo Team: MCNP – A General N-Particle Transport Code Version 5 – Volume I: Overview and Theory, LA-UR-03-1987, Los Alamos National Laboratory Los Alamos, N. Mex., USA (2003).
- [29] Goorley, T., *et al.*, Initial MCNP 6 Release Overview, LA-UR-11-07082, Los Alamos, National Laboratory, also *Nuclear Technology*, 180 (2012), Dec., pp. 298-315
- [30] Chadwick, M. B., *et al.*, ENDF/B-VII.1 Nuclear Data for Science and Technology: Cross Sections, Covariances, Fission Product Yields and Decay Data, *Nucl. Data Sheets*, 112 (2011), pp. 2887-2996
- [31] Pešić, M. P., MCNP5 Study Kinetic Parameters of Coupled Fast-Thermal System HERBE, *Nucl Technol Radiat*, 26 (2011), 2, pp. 136-139
- [32] Pešić, M. P., A Study on the Use of the Reactor Basic Experiments in the U- D_2O Lattices of the RB Critical Assembly for Validation of Modern Nuclear Data Libraries, *Nucl Technol Radiat*, 31 (2016), 1, pp. 1-15
- [33] Mayer, K., *et al.*, Nuclear Forensics: A Methodology Applicable to Nuclear Security and to Non-Proliferation, International Nuclear Physics Conference 2010 (INPC2010), *Journal of Physics: Conference Series*, 312 (2011), 062003
- [34] Mayer, K., *et al.*, Uranium from German Nuclear Power Projects of the 1940s – A Nuclear Forensic Investigation, *Angewandte Chemie, International Edition*, 54 (2015), 127, pp. 13452-13456
- [35] ***, The e-mails of Evronik Industries AG Central Archive to M. P. Pešić on 2017-08-17 and 2017-09-05
- [36] ***, Nuclides and Isotopes, 16th edition, Revised 2009 by Baum, E. M., Knox, H. D. & Miller, T. R. – © 2002 KAPL, Inc., USA, 2009
- [37] Tuli, J. K., Nuclear Wallet Cards, 8th edition, National Nuclear Data Center, Brookhaven National Laboratory, Upton, NY USA, October 2011
- [38] ***, The e-mail of Dr. Maria Wallenius to M. P. Pešić on 2017-09-04

*According to [9] there are many inconsistencies and incorrect data in the reference [18]

- [39] Dahl, P. F., Heavy Water and the Wartime Race for Nuclear Energy, CRC Press, Boca Raton, Cal., USA, 1999
- [40] Harteck, P., Die Produktion von Schwerem Wasser, Unclassified Internal Report in [22], Hamburg, Germany (1941). pp. 1-8
- [41] Pešić, M. P., RB Reactor: Lattices of 2 % Enriched Uranium Elements in Heavy Water, International Reactor Physics Evaluated Experiments Project, IRPhEP, NEA/NSC/DOC(2006)1, contribution RB-FUND-EXP-004-CRIT, pp. 2+146, OECD/NEA, Nuclear Science Committee, Paris, France, March 31, 2013
- [42] *** Hitler's Sunken Secret, an Interview, PBS Airdate (November 2005), According NOVA Production of WBGH Boston MA USA, www.pbs.org
- [43] ***, <https://en.wikipedia.org/wiki/Graphite>
- [44] McConnell, J. R., *et al.*, Compendium of Material Composition Data for Radiation Transport Modeling, PIET-43741-TM-963, PNNL-15870 rev.1. p. 112, Pacific Northwest National Laboratory PNNL, Richland, Wash., USA, March 4, 2011
- [45] ***, Heisenberg Family Web Site: <http://www.heisenbergfamily.org/>.
- [46] ***, http://military.wikia.com/wiki/Alsos_Mission
- [47] Profio, A. E., Experimental Reactor Physics, John Wiley & Sons Inc., 1976, pp. 603-611
- [48] Popović, D., Osnovi Nuklearne Tehnike (Fundamentals of Nuclear Engineering) (in Serbian), Naučna knjiga, Beograd, 1970
- [49] Tipton, C. R., Jr.: Reactor Handbook, Volume I: Materials, p. 105, 2nd Edition (revised and enlarged), prepared under USAEC, Interscience Publishers, Inc. New York, 1960
- [50] NCCP, Products Catalogue, (in Russian and English: Nuclear Fuel for Research Reactors), Novosibirsk, Russian Federation, 2004, p. 4
- [51] ***, International Alloy Designations and Chemical Composition Limits for Wrought Aluminum and Wrought Aluminum Alloys, revision 2015, the Aluminum Association Inc., www.aluminum.org, Arlington, VA USA, 2015
- [52] ***, The JEFF-3.2 Evaluated Nuclear Data Files Library, The Java-Based Nuclear Data Information System, JANIS-4.0 Software Package, <http://www.oecd-nea.org/janis/>, OECD, Paris, France September, 2013

Received on October 11, 2017

Accepted on February 3, 2018

Милан П. ПЕШИЋ

ЈЕДАН НОВИ ПРИСТУП МОДЕЛОВАЊУ „В-VIII” СИСТЕМА, КРАЈЊЕМ ДОСТИГЊУЊУ ДРУГОГ УРАНИЈУМСКОГ ДРУШТВА

Нацистичка немачка држава спроводила је истраживања у нуклеарним технологијама као покушај да постигне различите циљеве у војним применама. Као резултат тих истраживања, немачки научници су развили разноврсне, напредне нуклеарне технологије у годинама пре и за време Другог светског рата. У покушају да развију „Уранмашину”, у којој се може постићи контролисано ослобађање велике енергије у процесу фисије, различити приступи су испитивани, теоријски и експериментално. Ова изучавања су извођена уз подршку Немачке нацистичке државе и била су позната као прво и друго „Уранијумско друштво/клуб”. Верзије „Уранмашина” су биле засноване, пре свега, на гориву од природног уранијума и тешкој води, обичној води или парафину као модератору. Последњи познати фисиони уређај био је поткритичан нуклеарни реактор Б₈ (В-VIII), који је (поново) изграђен у селу Хајгерлох (Haigerloch) у Јужној Баварској у првим месецима 1945. То је био уређај танк типа са горивом од природног уранијум метала и модератором од тешке воде, рефлектован графитом. Радијациона заштита уређаја остварена је примарно, окружењем реакторског танка обичном водом. Целокупна конструкција уређаја била је смештена унутар бетонског отвора у поду једне подземне пећине, бившег пивског подрума. Скорашња студија овог реактора је урађена, уз претпоставку апроксимације горива као шипки, усредњеног са припадајућом алуминијумском жицом и модератором, од стране ЛИН (Laboratorio Ingegneria Nucleare) истраживачке групе са Универзитета у Болоњи, Италија, 2009. године.

Овај рад представља сасвим нову студију Б₈ реактора уз покушај да се формира реална геометрија горива и модератора, указујући на многобројне апроксимације и упрошћења учињена приликом моделовања материјалних и геометријских карактеристика Б₈ уређаја, настала услед недостатка или несагласности података. MCNP6.1 рачунарски програм заснован на Монте Карло методи, са АСЕ библиотеком неутронских нуклеарних података искоришћен је за ту сврху. У раду се испитује утицај на критичност бројних неодређености у саставу материјала, густини и геометријским подацима уређаја. Додатно је учињен покушај процене неодређености наведеног експерименталног резултата мерења неутронске мултипликације. Покушано је да се анализирају и објасне добијене разлике између измерене вредности и прорачунатих вредности. Ове нове анализе потврдиле су да је Б₈ био дубоко поткритичан уређај, као што су то показали експериментални резултати немачких научника добијени марта-априла 1945. године у Хајгерлоху.

Кључне речи: нацистички нуклеарни програм, В-VIII, фактор мултипликације неутрона, MCNP6.1