

Influence of easily ionised elements on the delayed responses of the emission intensities of an analyte in a power modulated U-shaped argon stabilised DC arc plasma with an aerosol supply

MIROSLAV KUZMANOVIĆ^{1*}, JELENA SAVOVIĆ^{2#}, MIRJANA PAVLOVIĆ^{2#}, MILOVAN STOILJKOVIĆ^{2#}, ANKICA ANTIĆ-JOVANOVIĆ^{1#} and MOMIR MARINKOVIĆ²

¹*Faculty of Physical Chemistry, University of Belgrade, P. O. Box 137, 11001 Belgrade and*
²*“Vinča” Institute of Nuclear Sciences, P. O. Box 522, 11001 Belgrade, Serbia and Montenegro*
(e-mail: miroslav@ffh.bg.ac.yu)

(Received 30 August, revised 10 November 2004)

Abstract: The current of a U-shaped argon stabilised DC arc was square modulated with a 40 Hz repetition frequency between 6 and 3 A. The delayed line intensity responses to the modulation of the arc current were investigated using calcium as a representative analyte. The intensities of both the atomic and ionic lines were monitored at different distances from the arc axis in the presence of various concentrations of the easily ionised element. Temporal evolutions were monitored on a millisecond time scale. It was found that the responses of the line intensity to the arc current change strongly depended on the observed radial position, especially in the vicinity of the arc axis. The obtained results showed a significant influence of even small amounts of the easily ionised element on the excitation and transport of the analyte and indicated a way of possibly improving the analytical capabilities of the excitation source.

Keywords: DC plasma, U-shaped arc, power modulation, delayed responses, easily ionised elements.

INTRODUCTION

Square power modulation induces various processes in a plasma, which are reflected on the temporal evolution of the line intensities. A sudden change of the arc current is followed by various responses of a line intensity, ranging from a few microseconds to several milliseconds. On the microsecond time scale, thermalization processes follow a sharp change of the arc current. Ionisation and recombination processes occur within a time scale of several hundred microseconds, while transport processes, caused by diffusion, have time constant in the millisecond domain. In plasma diagnostics and in the study of excitation mechanisms, especially for power interruption, investigations of responses in the microsecond time domain

* Author for correspondence.

Serbian Chemical Society active member.

are widely used.^{1–3} However, only a few papers deal with delayed responses in the millisecond time range, and they are mainly concerned with an inductively coupled plasma excitation source.^{4–6}

Measurement of the radial distributions of the electron number density (n_e) and the excitation temperature (T_{exc}) in a U-shaped argon stabilised DC arc for an arc current of 7.5 A have been reported.^{7,8} Detailed investigation of the radial distributions of n_e and T_{exc} in a vertical, argon stabilised, DC arc were performed⁹ for arc currents ranging from 3 to 10 A and for various concentrations of added KCl as an easily ionised element (EIE). Despite the significant difference in the construction of these two arc devices, the results for the vertical arc can also be approximately applied for a U-shaped DC arc. The obtained results showed the existence of great n_e and T_{exc} gradients in the radial direction.

The radial distributions of both n_e and T_{exc} are characterised by a slow decline in the region of the arc core. The introduction of an EIE results in a lowering of the n_e and T_{exc} gradients, especially at the periphery of the arc. A steep decrease of n_e and T_{exc} was observed at radial positions (r) from 0.5 to 2.5 mm, depending on the arc current and the concentration of an EIE in the nebulised solution. For example, for an arc current of 6 A (without EIE), the temperature at the arc axis was 8500 K, at $r = 0.8$ mm 7900 K and at $r = 2$ mm only 4500 K. Simultaneously, the value for n_e decreased from $3 \times 10^{21} \text{ m}^{-3}$ at the arc axis, $2.5 \times 10^{21} \text{ m}^{-3}$ at $r = 0.6$ mm to 10^{20} m^{-3} at $r = 1.5$ mm.⁹ This sharp decrease of the parameters was observed at radial positions closer to the arc axis for lower arc currents and higher EIE concentrations. When the concentration of EIE was large enough and the arc current was low enough, these gradients almost disappeared. For example, for 2 % KCl and 3 A, the temperature at the arc axis was 4000 K and at $r = 3$ mm it was 3500 K,⁹ while for the same current but without added EIE, the temperature at the arc axis was 7500 K.¹⁰

Large temperature and electron pressure gradients induce a strong radial electric field as a consequence of the different mobilities of electrons and ions. The radial electric field induces a demixing effect,¹¹ *i.e.*, the displacement of a partially ionized analyte from the hotter regions of the arc column. The shift of the radial distribution of the emission of analyte atoms and ions from the arc axis region increases with decreasing first ionisation energy of the analyte. This argument was used for the successful modelling of the influence of an EIE on the emission of an analyte.¹²

Increasing the concentration of an EIE in the plasma generates a radial distribution of the analyte emission closer to the arc axis by reducing the radial electric field. With increasing arc current, the gradient of the electron concentration towards the periphery increases, which produces a shift of the emission from the arc axis. It is noteworthy that the atomic and ionic distributions are similar in all respects except that the ionic distributions are closer to the arc axis. Spatial and temporal responses to modulations of the arc current give an insight into the mechanism of the influence of an EIE on the transport of an analyte.

In this work, the influence of an EIE on the temporal evolution of the intensity of a spectral line caused by current modulation was studied in order to obtain a better understanding of the demixing effect and excitation and transport processes, and investigate possible improvements of the analytical properties of an argon stabilised DC arc plasma. Particular attention was paid to the processes connected to the drop of the arc current. Calcium was chosen as a representative analyte, while potassium was used as a typical EIE.

EXPERIMENTAL

The measurements were carried out on a U-shaped DC argon arc stabilized by combined gas and wall stabilization. A detailed description of the arc device used in this work is given in Ref. 13. The analytical capabilities of the source have been the subject of several papers.¹³⁻¹⁵ Analyte solutions containing different amounts of KCl (from 0 to 2 %) were nebulized with a glass concentric nebulizer and introduced into the plasma tangentially to the arc axis. The horizontal part of the arc

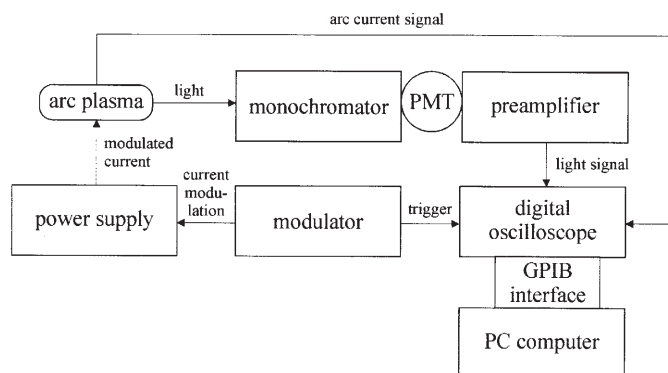

Fig. 1. Schematic representation of the experimental setup.

column with its axis parallel to the optical axis was focused on the entrance slit of a monochromator with photoelectric detection. Radial distribution measurements were performed by moving the arc device perpendicular to the optical axis of the monochromator. Square current modulation was realized using an electronic fast switch circuit. The current transition time (between 6 and 3 A) was a few microseconds, which was accomplished by careful optimisation of the electric circuit, *i.e.*, by minimizing the reactive resistance of the circuit. The low current period lasted 5 ms with a repetition period of 25 ms. The temporal responses were acquired using a digital storage oscilloscope controlled by a PC computer. The experimental setup, presented schematically in Fig. 1, was explained in detail previously.¹⁶

RESULTS AND DISCUSSION

The temporal evolutions of the Ca I 422.67 nm line intensity at various radial positions are presented in Fig. 2.

At larger distances from the arc axis, the intensity slowly and monotonously decreases after the sharp current change from 6 to 3 A, presumably because it follows the temperature change towards the stationary value corresponding to the lower current. This behaviour is expected and can easily be explained by the fact that, at the arc periphery, the electron and gas temperatures are equal and there are no sharp plasma parameter gradients. At distances close to the arc axis, at the moment of the current drop,

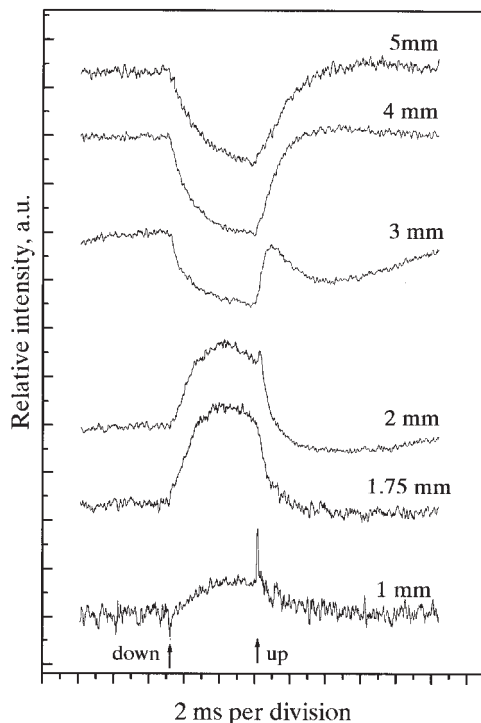

Fig. 2. Temporal responses of the Ca I 422.67 nm line intensity in the absence of KCl in the nebulized solution, at different distances from the arc axis. The moments of the sudden current change are marked with arrows.

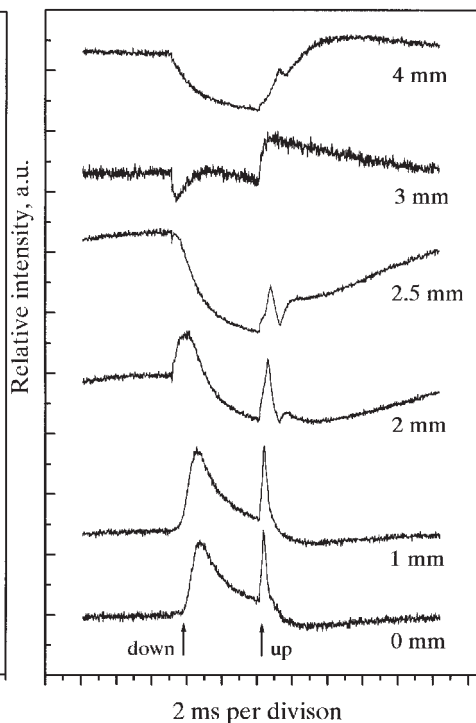

Fig. 3. Temporal responses of the Ca I 422.67 nm line intensity in the presence of 0.5 % KCl in the nebulized solution, at different distances from the arc axis.

the intensity first increases and then even slowly decreases due to the decrease of the plasma temperature. A detailed description of this phenomenon will be given later when the temporal responses in the presence of KCl in the solution are considered.

The intensity responses of the calcium atomic line at different distances from the arc axis when the nebulized solution contained 0.5 % KCl are presented in Fig. 3.

As can be seen, at distances close to the arc axis, the current drop is accompanied by an increase of the intensity of the calcium atomic line. This intensity increase, despite the temperature fall,^{10,16} has to be forced by an increase of number density of the analyte atoms, hence, special attention should be given to processes which may contribute to a concentration increase. The current drop causes a decrease of the temperature at the arc axis and a decrease of the radial electric field. Therefore, a pressure fall will be followed by gas transport from the periphery, which results in an increase of the number density of the analyte atoms. Analyte transport is also supported by a decrease of the radial electric field.¹¹ Recombination, due to the temperature drop, may also contribute to the observed intensity jump.

The temporal responses of the intensity of the Ca II 393.37 nm line at different radial positions in the presence of 0.5 % KCl are shown in Fig. 4.

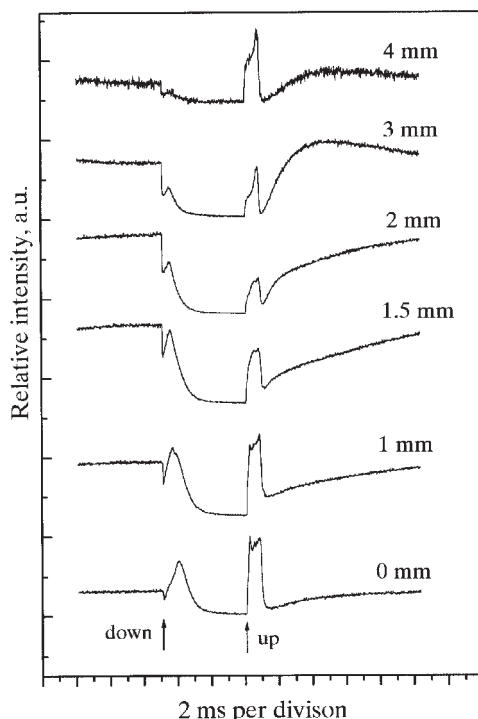

Fig. 4. Temporal responses of the Ca II 393.37 nm line intensity in the presence of 0.5 % KCl in the nebulized solution, at different distances from the arc axis.

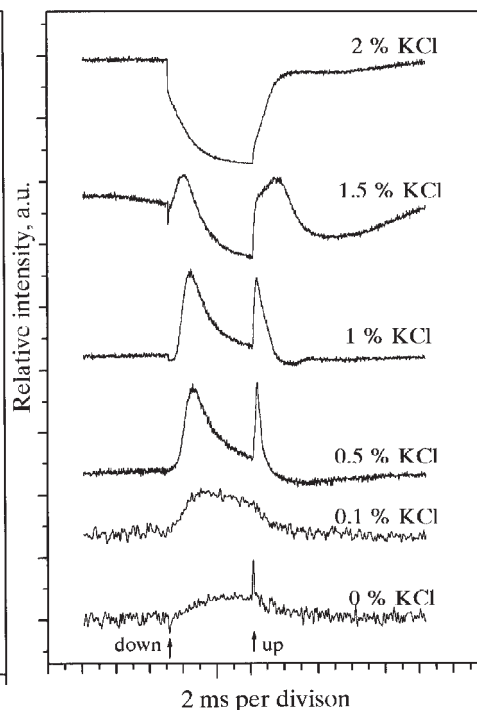

Fig. 5. Temporal responses of the Ca I 422.67 nm line intensity as a function of KCl concentration in the nebulized solution, at a distance of 1 mm from the arc axis.

As can be seen, the temporal evolutions of the intensity of the calcium ionic line resemble those obtained for the atomic line. The fact that the previously mentioned intensity increase can also be observed for the ionic line excludes a dominant role of recombination. The sharp intensity fall preceding the intensity increase (Fig. 4) is the consequence of a fall of the electron temperature to the value corresponding to the low arc current at the observed plasma region. This sharp intensity fall in the microsecond time scale appears because of the difference of the electron temperature at the high and low arc current in plasma regions closer to the arc axis.^{10,16} The absence of a fast intensity decrease of the atomic line is the result of the prevalence of fast recombination. At larger distances from the arc axis, the intensity jump is less prominent as a consequence of the smaller temperature and electron number density gradients, and it completely disappears at a certain distance. The radial distribution of ions is closer to the arc axis, and the intensity jump of the ionic line diminishes at shorter distances than that of the atomic line.

Preliminary investigations for elements with a high ionisation energy confirmed the assumption that the intensity increase following the current drop is predominantly caused by a decrease of the radial electric field. The radial electric field

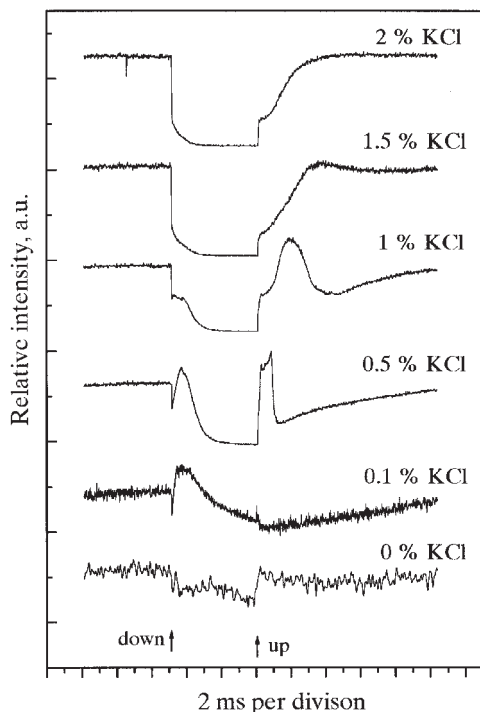

Fig. 6. Temporal responses of the Ca II 393.37 nm line intensity as a function of KCl concentration in the nebulized solution, at a distance of 1 mm from the arc axis.

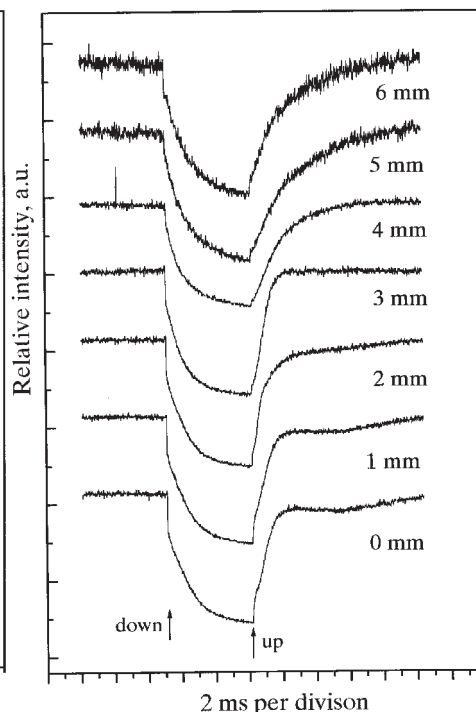

Fig. 7. Temporal responses of the Ca I 422.67 nm line in the presence of 2% KCl in the nebulized solution, at different distances from the arc axis.

is strongest at the positions where the n_e gradients are largest and these are the positions where its fall have the most significant influence on the transport of analyte particles. The decrease of the electrostatic barrier causes the transport of analyte towards the arc axis and is manifested as an intensity increase of the appropriate temporal responses. As can be seen in Figs. 2 and 3, the increase of intensity diminishes at a radial position between 2 and 3 mm (depending on the current and the EIE concentration), in accordance with the fact that at those distances the n_e and T_{exc} gradients become considerably smaller.

The influence of KCl added to the nebulized solutions on the evolution of the intensity of the atomic and ionic calcium lines is significant, as it may be seen by comparing Figs. 2 and 3 with Figs. 5 and 6. Even a small addition of an EIE (0.1% KCl) considerably changes the shape of the responses, which can be explained by the differences in the peripheral radial distributions¹² of n_e in the presence and absence of an EIE.

The increase of the intensity is most evident with an addition of KCl up to 0.5%. The increase becomes smaller with further addition of KCl, and finally it disappears in the presence of 2% KCl (Fig. 5). The radial distance, for which the intensity increase is still noticeable, decreases with increasing concentration of KCl. This be-

haviour can be explained in terms of the influence of an EIE on the radial electric field.¹² The introduction of an EIE weakens the radial electric field and shifts the radial distribution of the emission of an analyte closer to the arc axis. Increasing the concentration of KCl lowers the influence of recombination by suppressing the ionisation of an analyte in the stationary state, and at higher KCl contents (> 1 %) a sharp drop in the intensity appears for the atomic line as well (Fig. 5).

In the presence of 2 % KCl in nebulized solution, the temporal evolutions of the line intensities are rather different (Fig. 7). At distances from the arc axis between 0 and 4 mm, the arc current decrease is followed by a large intensity decrease, and the arc current increase by a fast intensity increase, as a consequence of $T_e - T_g$ difference. Between these fast intensity changes, the intensity slowly declines due to the temperature decrease, as was the case at lower EIE concentrations at large radial distances. Such a behaviour is the result of the large decrease in the n_e and T gradients, resulting from the influence of the large amounts of the EIE.^{9,17}

The intensity increase following the current jump is the consequence of a much faster temperature jump compared to the diffusion of the heavy particles. In other words, at the moment of the current jump, the analyte concentration is larger than it should be for this higher temperature. The intensity then decreases and reaches the stationary value, because the analyte concentration is decreased by transport (towards the periphery) supported by an increase of the radial electric field. The intensity peak following the current jump disappears when the concentration of the EIE is large enough for the actual arc current because of the much smaller gradients and temperature.^{9,17}

CONCLUSION

The obtained results show that the addition of KCl to the nebulized solutions at concentrations up to 0.5 % has a large effect on the emission intensities. The magnitude of the effect is strongly dependent on the radial position in the plasma and the concentration of the added KCl. The broad intensity peaks which follow the current drop or jump are a consequence of diffusion processes of the analyte. The assumption that diffusion improves as the analyte enters closer to the arc core zone due to, the decrease of the radial electric field playing the dominant role is supported by comparing the present results with those obtained for non-easily ionised elements, when no intensity increase is observed.

In the obtained temporal evolutions, there are time intervals in which the intensity is much higher than in the stationary state, and this fact may be used to improve the analytical capabilities of DC arc plasmas. Of special interest is the fact that the intensity increase after the arc current drop is followed by a lowering of the background intensity, giving the opportunity of achieving a better signal to noise ratio.

Acknowledgement: This work was supported by the Ministry of Science and Environmental Protection, Republic of Serbia; Projects No. 1928 and 1995.

ИЗВОД

УТИЦАЈ ЛАКО ЈОНИЗУЈУЋИХ ЕЛЕМЕНАТА НА СПОРЕ ОДЗИВЕ
ИНТЕНЗИТЕТА ЕМИСИЈЕ АНАЛИТА У СТРУЈНО МОДУЛИСАНОЈ ПЛАЗМИ
ЈЕДНОСМЕРНОГ АРГОНОМ СТАБИЛИЗОВАНОГ ЛУКА U-ОБЛИКА СА
УВОЂЕЊЕМ АЕРОСОЛА

МИРОСЛАВ КУЗМАЊОВИЋ¹, ЈЕЛЕНА САВОВИЋ², МИРЈАНА ПАВЛОВИЋ², МИЛОВАН
СТОИЉКОВИЋ², АНКИЦА АНТИЋ-ЈОВАНОВИЋ¹ и МОМИР МАРИНКОВИЋ²

¹Факултет за физичку хемију, Универзитет у Београду, б. бр. 137, 11001 Београд и ²Институт за нуклеарне науке Винча, б. бр. 522, 11001 Београд

Струја аргоном стабиланог DC лука U-облика правоугаоно је модулисана између 6 и 3 А, са фреквенцијом понављања од 40 Hz. Спори одзиви интензитета емисије на модулацију струје лука праћени су за спектралне линије калцијума као репрезентативног анализата. Проучаване су и атомске и јонске линије на различитим растојањима од осе лука за различите концентрације додатог лако јонизујућег елемента као спектрохемијског уједначивача (од 0 до 2 % KCl) у распршиваним растворима. Временска еволуција праћена је на милисекундној временској скали. Из добијених одзива интензитета уочљива су два карактеристична максимума која прате наглу промену струје лука. Одзиви јако зависе од посматраног радијалног положаја, нарочито на растојањима ближе оси лука. Појава ових максимума последица је дифузије честица анализата до које доводи модулација струје. Добијени резултати показују да и мале количине додатог KCl имају значајан утицај на ексцитацију и транспорт анализата и наговештавају могућност побољшања аналитичких могућности овог ексцитационог извора.

(Примљено 30. августа, ревидирано 10. новембра 2004)

REFERENCES

1. D. B. Gurevich, V. I. Podmoshenskii, *Opt. Spectrosc.* **15** (1963) 319
2. E. L. Bydder, G. P. Miller, *Spectrochim. Acta* **43B** (1988) 819
3. F. H. A. G. Fey, J. M. de Regt, J. A. M. van der Mullen, D. C. Schram, *Spectrochim. Acta* **46B** (1991) 885
4. P. B. Farnsworth, *Appl. Spectrosc.* **39** (1985) 1078
5. G. D. Rayson, D. Y. Shen, *Spectrochim. Acta* **47B** (1992) 553
6. C. E. Hensmen, R. D. Lawrence, G. D. Rayson, *Spectrochim. Acta* **52B** (1997) 503
7. M. S. Pavlović, N. Z. Pavlović, M. Marinković, *Spectrochim. Acta* **46B** (1991) 1487
8. G. Malović, M. Tripković, I. Holclajtner-Antunović, *Contrib. Plasma Phys.* **34** (1994) 773
9. M. Stoiljković, *MSc Thesis*, University of Belgrade, Faculty of Physical Chemistry (1995)
10. M. M. Kuzmanović, A. Antić-Jovanović, M. Stoiljković, M. S. Pavlović, M. Marinković, *Spectrosc. Lett.* **36** (2003) 303
11. M. S. Pavlović, M. Marinković, *Spectrochim. Acta* **53B** (1998) 81
12. M. S. Pavlović, M. M. Kuzmanović, V. M. Pavelkić, M. Marinkovic, *Spectrochim. Acta* **55B** (2000) 1373
13. M. Marinkovic, V. G. Antonijevic, *Spectrochim. Acta* **35B** (1980) 129
14. M. M. Kuzmanović, M. S. Pavlović, M. Marinković, *Spectrosc. Lett.* **29** (1996) 205
15. M. Tripkovic, I. Holclajtner-Antunovic, M. Marinkovic, D. Markovic, *J. Serb. Chem. Soc.* **66** (2001) 249
16. M. M. Kuzmanovic, M. S. Pavlovic, J. J. Savovic, M. Marinkovic, *Spectrochim. Acta* **58B** (2003) 239
17. M. Marinković, B. Dimitrijević, *Spectrochim. Acta* **23B** (1968) 257.