

IMPROVEMENT OF ENVIRONMENTAL ASPECTS OF THERMAL POWER PLANT OPERATION BY ADVANCED CONTROL CONCEPTS

by

**Robert A. MIKULANDRIĆ^{a*}, Dražen M. LONČAR^a, Dejan B. CVETINović^b
Gabriel SPIRIDON^c, and Daniel R. SCHNEIDER^a**

^a Faculty of Mechanical Engineering and Naval Architecture, University of Zagreb, Zagreb, Croatia

^b Vinča Institute of Nuclear Science, University of Belgrade, Belgrade, Serbia

^c R&D Institute for Scientific Research and Technological Engineering for Automation - IPA SA,
Bucharest, Romania

Original scientific paper

DOI: 10.2298/TSCI120510134M

The necessity of the reduction of greenhouse gas emissions, as formulated in the Kyoto Protocol, imposes the need for improving environmental aspects of existing thermal power plants operation. Improvements can be reached either by efficiency increment or by implementation of emission reduction measures. Investments in refurbishment of existing plant components or in plant upgrading by flue gas desulphurization, by primary and secondary measures of nitrogen oxides reduction, or by biomass co-firing, are usually accompanied by modernisation of thermal power plant instrumentation and control system including sensors, equipment diagnostics and advanced controls. Impact of advanced control solutions implementation depends on technical characteristics and status of existing instrumentation and control systems as well as on design characteristics and actual conditions of installed plant components. Evaluation of adequacy of implementation of advanced control concepts is especially important in Western Balkan region where thermal power plants portfolio is rather diversified in terms of size, type and commissioning year and where generally poor maintenance and lack of investments in power generation sector resulted in high greenhouse gases emissions and low efficiency of plants in operation. This paper is intended to present possibilities of implementation of advanced control concepts, and particularly those based on artificial intelligence, in selected thermal power plants in order to increase plant efficiency and to lower pollutants emissions and to comply with environmental quality standards prescribed in large combustion plant directive.

Key words: *West Balkan energy efficiency, information and communication technology based systems, artificial intelligence, coal combustion modelling and control, emission mitigation*

Introduction

West Balkan countries (WBC) are heading towards EU integration. Due to EU membership, WBC will be forced to comply with current EU legislative related to thermal

* Corresponding author; e-mail: robert.mikulandric@fsb.hr

power plant efficiency and emission control. All EU member countries have ratified the Kyoto protocol which requires energy consumption and emission pollution decreasing. EU parliament has promoted numerous obligations, laws and Directives to meet goals from the Kyoto protocol and to reduce environment pollution.

Most of EU countries have started the process of shutting down old and inefficient power plants which are mostly coal and heavy oil fired. Additional investments into these thermal power plants (TPP) and their refurbishment become unnecessary. Construction of new coal or heavy oil fired power plants is removed from large number of national energy strategies and replaced with construction of renewable energy based facilities in order to meet goals from Kyoto protocol and EU Directives.

One solution for emission mitigation problem is implementation of secondary measures technology in TPP. Some of secondary measures technologies for NO_x and SO_x reduction are selective catalytic reduction (SCR), selective non-catalytic reduction (SNCR), ammonia injection, ammonia scrubbers, oxygen-enriched combustion (OEC), and other measures described in [1, 2]. However secondary measures are investment intensive. Another solution is getting primary measures closer to the power plant processes limits using advanced techniques regarding power, temperature, combustion, and frequency control. These measures often prove to be very useful and cost effective [3]. But construction and simulation of such models (especially combustion models) by means of mathematical, physical and chemical analysis (with CFD programs) is very complex process with very long computation time. Because of this reasons, utilization of these models are impracticable for on-line power plant control [4].

Advanced control technologies for improving system operability and environment maintainability based on artificial-intelligence (AI) seems to be promising approach for modelling and controlling large and non-linear power generation processes.

West Balkan countries thermal power plant status

The power generated by fossil power plants represents about 59% (52% from coal, 4% from oil, and 3% from gas) of all produced power in the WB region [5]. Most of fossil power plants currently in operation were constructed mainly between 1955 and 1990 during lower emission restrictions. From 1991 till 2008 the technology of power generation and the environmental characteristics of the operating fossil fuel-fired plants in the WBC had not been improved considerably. This is a result of poor maintenance and lack of investments in the energy generation sector. All these factors finally result in high greenhouse gases emissions and low efficiency of WBC thermal power plants. Some of power plants were partially reconstructed (with introduction of ecology friendly technologies) which resulted in lower NO_x , SO_2 , and fly ash emissions. Some of the NO_x emissions restricting measures were made as primary measures.

On the other hand the secondary measures, which support the inhibition of already created NO_x , were not widely used mostly because of their high investment costs. Currently, the NO_x emissions in most of the fossil fuel power plants vary between 200 and 750 mg/Nm^3 [5], which is a considerable reduction in comparison to the past decades. Some of these emissions however still exceed today's EU limits and most of them exceed the future limits, coming to validity in 2016, setting the NO_x emissions limit to 200 mg/m^3 . Discharge of CO_2 is, however, comparable with EU TPP, which can be explained by the very nature of the system employed for energy transformation.

Domestically produced lignite and natural gas were important fuels for heavy industries during the era of central planning in the 1980s and 1990s. Demand for these fuels had decreased with the closure of most heavy industry. The lignite is of low quality with contents of sulphur (0.3 to 1%), ash (10 to 30%), and moisture (up to 60%) [6, 7]. It also has low calorific value (in the range of 4 500 to 10 000 kJ/kg). Western Balkan energy sector also faces some non-technical problems such as reorganisation of ownership structure, difficult working conditions, social issues, *etc.* [8].

General Western Balkan energy sector characteristics and key challenges are:

- lack of domestic capacity for thermal electricity generation,
- high energy intensity,
- higher energy consumption in the future due to economical expansion,
- low oil and natural gas reserves, fossil fuel import,
- domestically produced lignite of low quality,
- old TPP technology,
- lack of TPP maintenance,
- low TPPs efficiency,
- frequent TPP outages,
- SO₂ and NO_x emissions above EU limits,
- low investment possibilities in energy sector,
- coal preparing problem (milling, dosing, pre-heating), and
- poor power plant personnel process understanding.

Information and communication technology based systems

The primary task for power plant operation is to meet the load demand for electric power and to ensure stable, safe and efficient power generation. However, task of establishing optimal power plant operation processes seems to be very demanding.

Purely software-oriented approach to optimizing processes has been an ongoing success in the world's power plants for just on a decade now and has made many improvements regarding power plants operability, efficiency, *etc.* (tab. 1). Besides being widely incorporated into new power plants, process optimization is nowadays a popular choice for power plant upgrades. More and more operators are going beyond simply replacing

their old instrumentation and control systems and are taking the opportunity of a scheduled modernization to make their power plants more flexible to current market situation, which means greater flexibility and higher efficiency, better availability and lower emissions.

General benefits of information and communication technology (ICT) based systems for high flexibility is more flexible power generation which implies lower

Table 1. General classification of ICT based systems

ICT based system group	ICT based system
High flexibility	Power optimization
	Economic load allocation for boilers and turbines
	Combined cycle control tools
	Minimum load reduction
	Maximum load extension
	Fast load increase, fast TPP start-up, low loss TPP start-up
	Frequency control
High availability	Automatic runback control
	Low-stress operation
Low emissions	Emissions control
High efficiency	Advanced combustion optimization
	Temperature optimization

process losses during the load changes, start-ups and shut-downs. These loss reduction increases annual profit due to lower operational costs. Main disadvantages of ICT based systems for high flexibility is reduction of overall TPP efficiency and increment of annual emissions. Due to poor electricity market optimisation in WBC and high possibility of load regulation with hydro power plants, installation of high flexibility ICT systems do not offer great opportunities for TPP efficient increment and emission reduction in WB TPP.

Main advantage of higher TPP availability optimisation is extended service life. Although it deals with WB TPP requirements for extended lifetime (in correlation with lack of domestic capacity for thermal electricity generation), it does not lower emissions or increase efficiency, which is main challenge for WB TPP. Poor power plant personnel process understanding and marginal emission reduction with no efficiency increment are key drawbacks for emission control ICT systems implementation in WB TPP. Generally, implementation of emission control systems in TPP is key requirement to reduce emissions and to comply with large combustion plants (LCP) emission standards.

ICT based systems for high efficiency optimise TPP processes to increase TPP efficiency and due efficiency increment to lower emissions. Mentioned improvements are key challenges of WB TPP. Old emissions monitoring technology in WB TPP encounters with possibilities of ICT systems to improve efficiency. Implementation of ICT based systems for higher efficiency gives great opportunity to increase efficiency and to reduce emissions within primary measures technologies. With the need of power production increment in WB sector, introduction of ICT based systems for high efficiency into TPP control system as one of primary measure seems to be promising action to meet this goal.

Most of ICT based systems are implemented in coal TPP, mainly to increase efficiency and flexibility and therefore reduce emissions and operational costs. Croatia is most prominent in ICT based systems implementation (tab. 2).

Table 2. ICT based systems used in WBC TPP [9]

ICT based system group	ICT based system implemented	Thermal power plant	Country
High efficiency	Steam temperature optimization	Coal TPP 210 MW	Croatia
		Coal TPP 675 MW	Macedonia
High flexibility	Fast TPP start-up Frequency control	Coal TPP 210 MW	Croatia
		Coal TPP 210 MW	Croatia
High availability	Automatic runback control	Coal TPP 1650 MW	Serbia
Low emissions	Emissions control	Crude oil TPP 320 MW	Croatia

Comparative analysis of ICT based systems showed that the strongest way to compile with EU Directives and to minimize emissions and increase TPP efficiency is to introduce combustion or/and steam temperature optimization into WBC TPP. But only combustion optimization directly successfully encounters thermal power plant efficiency and emission mitigation at the same time [10].

Possibilities for artificial intelligence systems implementation in thermal power plants

Artificial intelligence systems (AIS) are widely accepted as a technology offering an alternative way to tackle complex and undefined problems. They can learn from examples, they are fault tolerant in the sense that they are able to handle noisy and incomplete data, they

are able to deal with non-linear problems, and once trained can perform prediction and generalization at high speed. They have been used in diverse applications in control, robotics, pattern recognition, forecasting, medicine, power systems, manufacturing, optimization, signal processing, and social/psychological sciences. They are particularly useful in system modelling such as in implementing complex mappings and system identification [11].

As mentioned in the section *Information and communication technology based systems*, the strongest way to reduce emissions and to improve efficiency is combustion process optimisation. Combustion optimisation is mostly conducted through fuel and air flow regulation. Conventional air flow control for combustion processes (see fig. 1) in coal TPP consists of four proportional-integral (PI) controllers. Based on required boiler thermal load, measured O_2 in flue gases on the boiler exit and firing requirements, first PI controller partially controls total air flow to minimize share of O_2 in flue gases. Secondary PI controller, based on boiler thermal load, measured total air flow and regulated air flow for O_2 minimization controls total air flow in combustion process. Total air flow is then divided into secondary air and tertiary air (air for additionally burning). Secondary air is subdivided for coal feeders where it is controlled separately. Based on coal feeder load, total secondary air for coal feeder is calculated. Secondary air for burners (inside same coal feeder) is then controlled separately, based on measured air temperature and calculated secondary air for coal feeder. Total tertiary air is calculated from boiler thermal load and total air flow. After that, tertiary air for every burner is controlled separately based on measured air temperature and calculated total tertiary air flow.

Parameters for conventional PI controller in air flow control must be carefully tuned to meet control demands in various operating condition. One approach to tackle changing process states is gain scheduling approach, where parameters for linear PI controller can be adjusted regarding different operating point of the system.

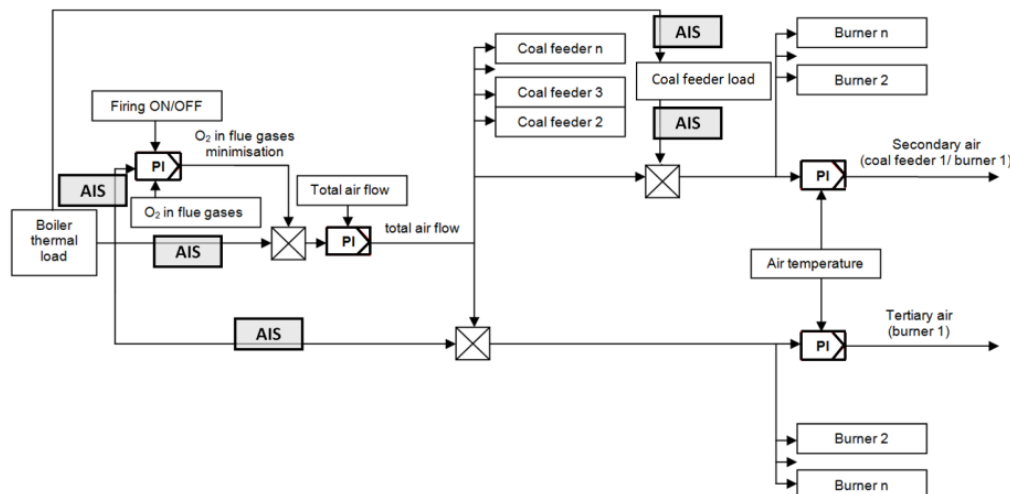

Figure 1. Appropriate places for AIS introduction to conventional air flow control

Calculation of total, secondary, and tertiary air flows based on boiler thermal load, coal feeder load and air temperature are purely linear. This calculation gives linear approximation of required air flows regarding input parameters. Processes behind these linear

approximations are very complex and highly non-linear, so by introducing linear approximations into process control, we introduce a certain error between calculated approximations and real process values. Neuro-fuzzy control has possibility to “learn” from input parameters to approximate parameter values from these processes. With better process models, the calculated approximations are closer to real process values. That gives more realistic input parameters for process control, and improve overall process control. Places for Artificial Intelligence Systems introduction to conventional air flow control is shown in fig. 1.

Artificial neural network and neuro-fuzzy combustion modelling and optimization methods can be divided into two stages. In the first stage, the relation between NO_x emissions and various operational parameters of the boiler is modelled. After that, operational parameters for low NO_x combustion are optimized. Optimization is based on previously constructed NO_x emissions model. NO_x emissions are often multi-dimensionally and highly non-linearly correlated to boiler operational parameters, so it is difficult to establish a perfect NO_x emissions predicting model. Due to high non-linearity, establishing NO_x emission predicting model depends on acquired (measured) emission data. Artificial neural-networks are well-known tools among artificial intelligence techniques, which are able to reproduce the relationships existing between input and output variables of highly non-linear systems [12]. In the second stage of combustion modification, some optimization algorithms are used to manipulate the inputs of the model in order to minimize the emissions output.

Coal combustion and NO_x emission modelling can be conducted through computational fluid dynamic (CFD) models [13, 14], but their very long computation time imposes need for different model that will be practical for on-line power plant control. Artificial neural networks and neuro-fuzzy models are currently the most researched approaches to and NO_x emission modelling [15]. They have proved their effectiveness on emissions prediction and control [16, 17]. For coal combustion modelling, support vector regression approach [12] and generic algorithm approach [12] can be used, where unknown parameters act as random variables with a known aprior probability distribution. The process identification then shifts into process observation (measured data).

Data processing and selection

For utilizing neuro-fuzzy learning algorithm, the probability model has to learn from observed/measured data. Data for learning algorithm were extracted from minute based field measurements on the 650 MW_e TPP „Nikola Tesla B“ (TENT B), Obrenovac, Serbia. Parameters, with resolution of 1 minute, selected for the purposes of neuro-fuzzy learning algorithm are: power output [MW_e], coal/heavy oil flow rate [%, m^3h^{-1}], total air quantity [Nm^3h^{-1}], oxygen content in furnace/flue gasses [%], feeder loads [%], secondary and tertiary air flow [Nm^3h^{-1}], fuel (coal and heavy oil) composition and air temperature [$^\circ\text{C}$]. Measurements of some of these parameters are shown in fig. 2.

Measured data have often some erroneous data due to human errors, faulty sensors *etc.* Because of that, before process prediction modelling and neuro-fuzzy learning algorithm utilization (neuro-fuzzy training), training data preprocessing is needed. Erroneous data (called “outliers”) have to be indentified and removed from neuro-fuzzy training data. Erroneous data is often very difficult to indentify due to large data sets. They can be identified and removed either by observing data sets or by implementation of user defined rule system for erroneous data identification. For initial erroneous data identification, standard deviation rule system ($\pm 3\sigma$) has been used.

Figure 2. Measured data from 650 MW_e coal fired/heavy oil TPP unit

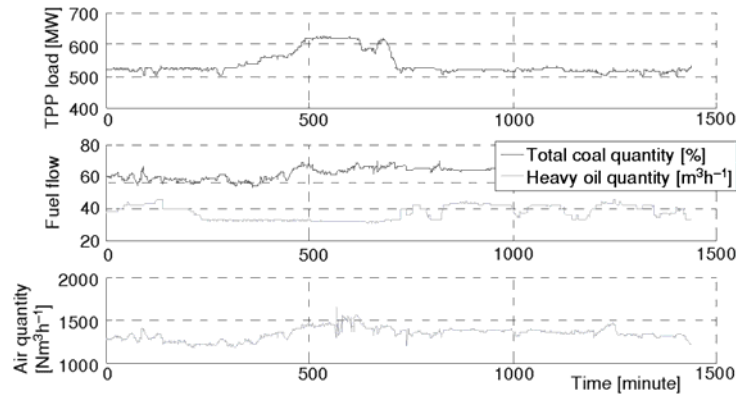

Some of secondary air flow measured values exceed upper or lower standard deviation limits (fig. 3). Due to this, they are removed from training data and replaced by interpolated value between values that are 3 minute before and 3 minute after erroneous data. Data values for interpolation are also checked to meet standard deviation rules before their usage.

Figure 3. Data selection process after initial erroneous data identification

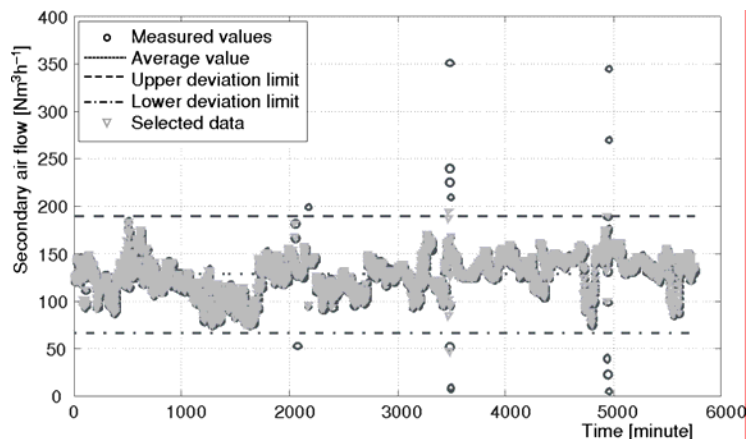

In some cases measured data can exceed deviation limits for a longer time. This is not because of human measuring error or sensors fault, but due to power plant operation changes. In this case, for shorter time, power plant operator had to increase heavy oil flow (fig. 4). Heavy oil flow values exceed upper deviation limits, but they are not erroneous data, so by that, they cannot be excluded from training data.

For identification of such process data, user defined data identification rule system has been devised. It takes into consideration measured values that are 5 minutes before and 5 minutes after current measured value. If the measured value that is 5 minute before or 5 minute after current value is also over (or below) deviation limit, current value for identification is considered valid for training data.

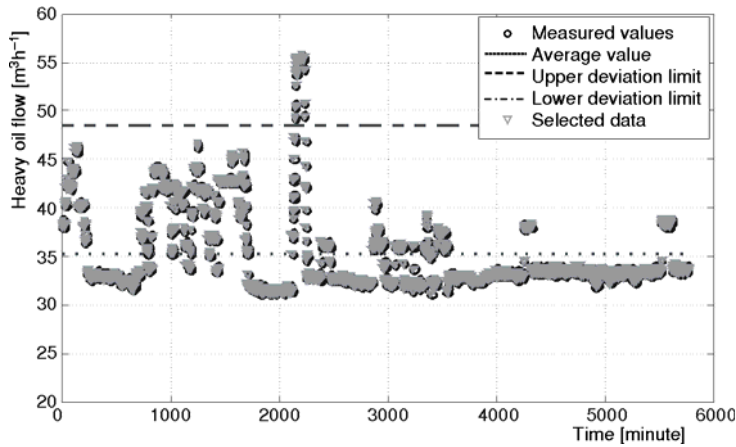

Figure 4. Data selection process after user defined data identification

After data selection, ANFIS total air flow prediction test model has been devised in MATLAB[®] programming environment [18]. Average error between measured and calculated values without data selection is 4.97%, while average error with data selection is 2.95% (fig.5).

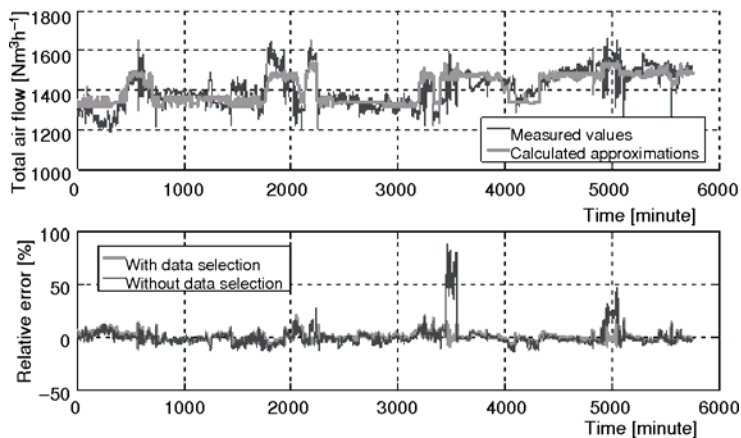

Figure 5. Selected data for artificial neural network training

Process parameter and emission prediction modelling

Measured process data such as NO_x and SO_x emission values are necessary for overall process evaluation. With NO_x and SO_x emission values database, process performance can be evaluated and eventually improved regarding emission mitigation.

In combustion process there are three primary sources of NO_x formation:

- (1) NO_x formation due to bound nitrogen in fuel (fuel NO_x).
- (2) Formation of NO_x due to high-temperature combustion and residence time of nitrogen molecules at that temperatures (thermal NO_x).
- (3) NO_x formation due to reaction of atmospheric nitrogen (prompt NO_x).

For NO_x emission calculation, Thompson *et al.* model has been used [18]. The NO_x formation rate is primary function of combustion process temperature. The higher the temperature, the NO_x formation rate is faster. In combustion process, fuel and air mixing imperfections effects NO_x formation. Consequently, due to fuel and air mixing imperfections, NO_x formation rate becomes affected by combustion temperature and air distribution.

When the fuel flow in burner increases, the turbulence in combustion area becomes greater and it improves mixing process. Simultaneously, the temperature is raised due to additional fuel. With adding more primary air to the burners, turbulence becomes grater, but the combustion temperature falls due to higher combustion losses:

$$\frac{dNO}{dt} = \alpha_0 W_f^r \left(1 + \alpha_1 \frac{\xi(t) - 55}{90} \right) \sqrt{\lambda_{st} - \lambda} \quad (1)$$

where α_0 and α_1 are reactions coefficients regarding fuel flow and burner tilt positions, W_f^r – fuel mass flow rate, $\xi(t)$ – burner tilt position (in percentage), λ_{st} and λ – stoichiometric and real fuel to air ratio. The more primary air is added to burner for combustion process, the higher oxygen concentration in flue gases is occurred:

$$\lambda_{st} - \lambda = \frac{v_a}{\beta} (O_2) \quad (2)$$

From eq. (2), eq. (1) becomes:

$$\frac{dNO}{dt} = \alpha_0 W_f^r \left(1 + \alpha_1 \frac{\xi(t) - 55}{90} \right) \sqrt{\frac{v_a}{\beta} (O_2)} \quad (3)$$

where v_a is specific volume of air ($v_a = 0.7767$), β – theoretical oxygen volume percentage for combustion process, and O_2 – oxygen concentration. Theoretical oxygen volume percentage for combustion processes can be calculated from fuel composition that is defined by:

$$\beta = 1.87C + 0.70S + 5.6H \quad (4)$$

where C , S , and H are mass content of carbon, sulphur and, hydrogen in fuel. Substituting eq. 4 into eq. 3 NO_x formation rate becomes:

$$\frac{dNO}{dt} = \alpha_0 W_f^r \left(1 + \alpha_1 \frac{\xi(t) - 55}{90} \right) \sqrt{\frac{v_a}{1.87C + 0.70S + 5.6H} (O_2)} \quad (5)$$

In this case, all the secondary damper positions are fixed during operation. Burner tilt positions which as percentage is ranging from 10% (lowest position) to 100% (highest position), setting 55% as middle position, are also fixed at 60%. After measurement of burner fuel and air flows on 650 MWe coal fired TPP, parameters α_0 , α_1 and r were chosen as 23.77, 0.438 and 0.25.

NO_x formation model has been used for NO_x values calculation on 650 MWe coal fired TPP. Burner load rate, burner primary air flow and O₂ concentration, both with coal composition are considered in equation.

Results

After processing all the data from 650 MWe coal fired/heavy oil TPP unit, ANFIS model for total, secondary and tertiary air values approximation has been devised in MATLAB[®] programming environment. For devising ANFIS model, Mamdani model with

Gauss membership functions has been used. In dependence of unit load and O₂ content in flue gases total air values have been calculated.

Steam boilers of the TENT B are designed for the domestic lignite from the coal mine „Kolubara“ as the main fuel. As start-up fuel heavy fuel oil is used. Fuel heating value has been taken as constant (based on main guaranteed design parameters of the coal). The lower heat capacity value of the fuel is 6.699 MJ/kg, the moisture content is 47.8%, the ash content is 19%, and the content of sulphur is 0.5%. In the real power plant operation this will not be the case. Fuel with different composition (heating value, moisture composition *etc.*) is used for combustion process. Lack of coal quality homogenization can cause problems from the point of combustion optimisation.

Only small divergence of the coal quality parameters (within the range of $\pm 5\%$) enables the optimization of the combustion process in the furnaces. However, due to the lack of homogenization, *i. e.* the equalization of the coal quality, the lower heat capacity of the coal supplied to the unit is in the range from 5 to 9 MJ/kg. Very often, during the winter season when energy demands are the highest, coal supplied to the TPP is extremely low quality with very high moisture content. In this situation, combustion support with heavy oil burners is necessary to reach nominal boiler load. Co-combustion of low quality lignite and heavy oil in the boiler furnace has to be carefully led from the unit operators to achieve optimal combustion. That is the additional reason for implementation of artificial system for combustion optimization.

ANFIS approximation model shows good correlation with measured values for total air flow calculation (fig. 6). The error between measured and calculated values is mostly between $\pm 10\%$ which represents good approximation of total air values in dependence of unit load and O₂ content in flue gases. Approximation errors of secondary and tertiary air are mostly between $\pm 20\%$ but in some marginal cases they can reach $\pm 50\%$. Measurement errors should also be considered.

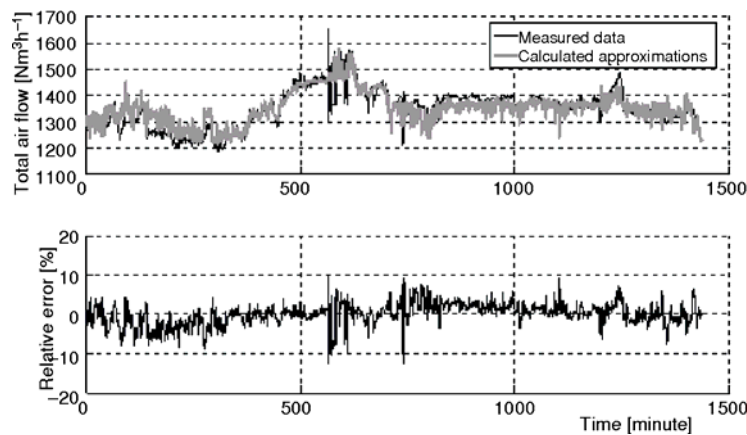

Figure 6. Calculated approximations of total air flow in comparison with measured values

Figure 7 shows calculated approximations of total air flow in dependence of unit load and O₂ content in flue gasses. It is obvious that total air flow dependence is highly nonlinear and that values of total air flow in power plant unit have a “saddle” around unit load of 540 MW. By increasing or decreasing unit load, current process total air flow increases. On constant unit load there is no obvious correlation between O₂ content and total air flow values.

Figure 7. Calculated approximations of total air flow in dependence of unit load and O₂ content in flue gasses

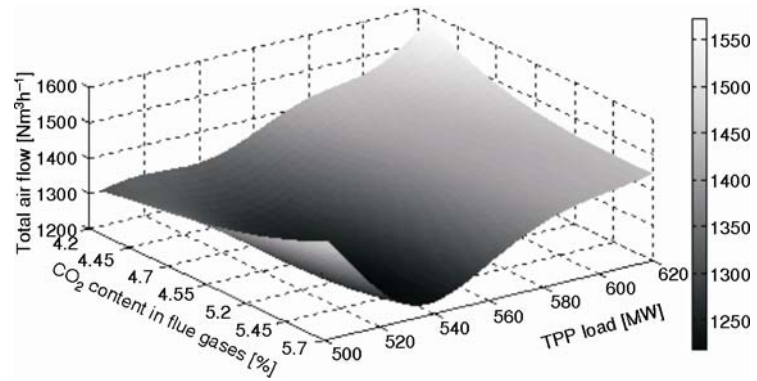

Figure 8 presents dependence of secondary air flow (on burner 1) on coal feeder load and total air flow while fig. 9 presents dependence of secondary air flow on total air flow and hot air temperature. Similar like in previous case, there is no obvious or linear defined correlation between secondary air flow, coal feeder load and total air flow.

Figure 8. Secondary air flow calculations in dependence of coal feeder load and total air flow

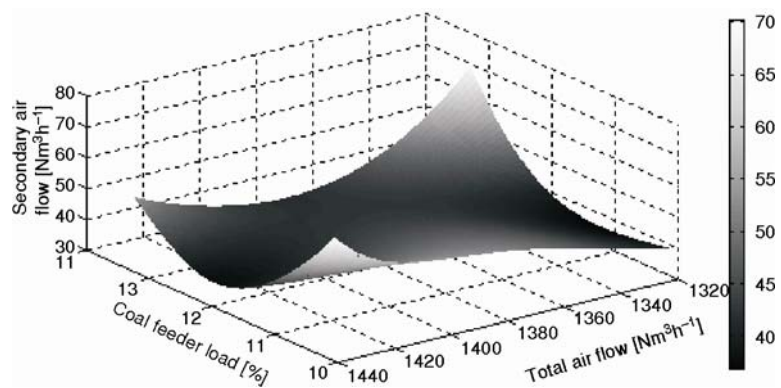

Figure 9. Secondary air flow calculations in dependence of total air flow and hot air temperature

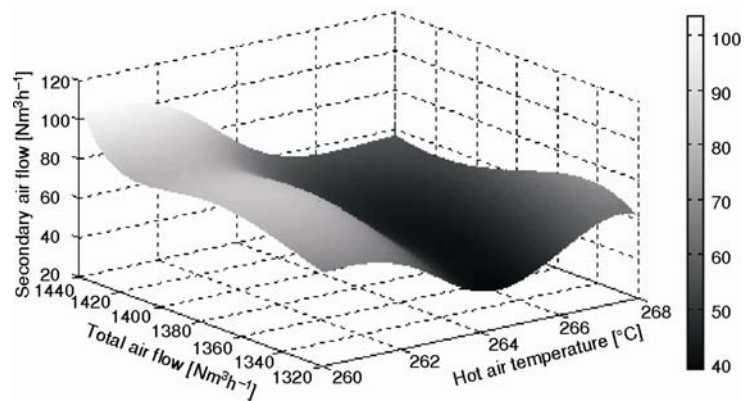

Figure 10 shows NO_x values during 24 hours power plant operation. NO_x values are ranging between 335 and 395 ppm, while power load is ranging between 500 and 625 MW_e . NO_x emissions are generally higher on lower power plant loads.

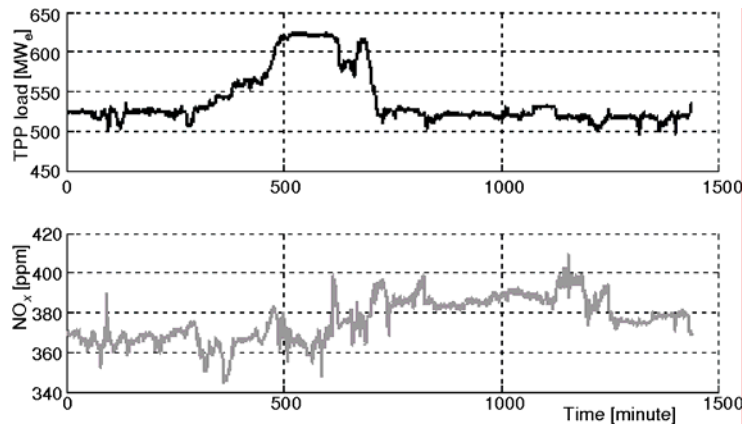

Figure 10. NO_x emission calculation in 650 MW_e coal fired unit

Generally, with unit load increment, NO_x emission values declines. On the same TPP output, with air flow increment, the NO_x emission rises (fig. 11). This is result of higher nitrogen input (derived from air) for combustion process. In this case, the temperature of combustion process is decreased which results in lower NO_x formation rate, but additional nitrogen that is introduced through air flow increases NO_x formation rate. General proposition for NO_x minimisation is to keep real fuel to air ratio close to its recommended values that ensures complete combustion process.

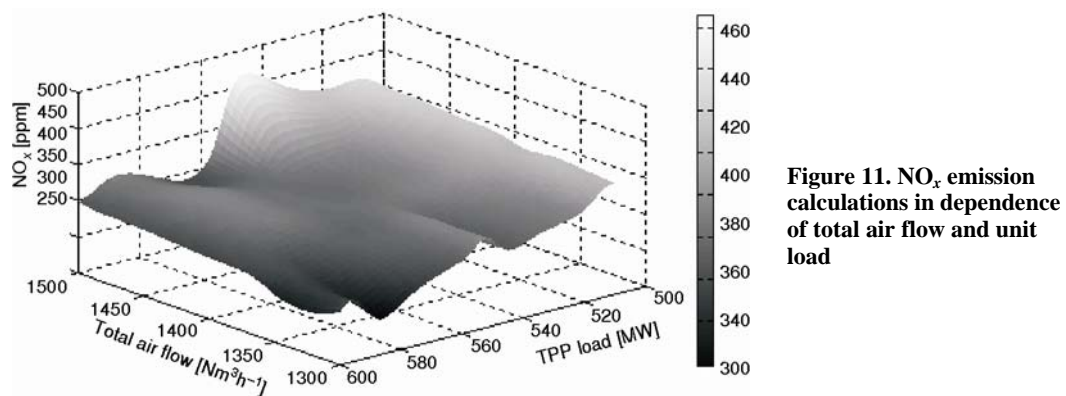

Figure 11. NO_x emission calculations in dependence of total air flow and unit load

Conclusions

This paper has analysed the possibilities of implementation of advanced control concepts, particularly those based on artificial intelligence, in WBC TPP in order to optimize combustion, increase plant efficiency and to lower pollutants emissions. General Western

Balkan energy sector characteristic is old and inefficient TPP technology and coal dependence with very low investment possibilities. Lack of investment possibilities imposes necessity of easily implementable, low cost solutions that encounters emissions and raises efficiency.

Combustion optimisation is the strongest way to directly influences emission mitigation and efficiency increment. Adaptive neuro-fuzzy algorithms can be used for combustion process parameter and emission prediction modelling. ANFIS approximation model for total, secondary and tertiary air values calculation both with fuel flow calculations shows good correlation with measured values and by this they can be used for process parameter and emission values prediction. ANFIS approximation model can be further used for combustion optimisation and emission minimisation purposes. Lack of some detailed process parameter data for process parameter prediction modelling could lead to misleading results and conclusions regarding further TPP combustion process interpretation and control and thus it should be analysed.

Acknowledgments

This paper has been created within WBalkICT-Supporting Common RTD actions in WBC for developing Low Cost and Low Risk ICT based solutions for TPP Energy Efficiency increasing, SEE-ERA.NET plus project in co-operation among partners from IPA SA-Romania, University of Zagreb, Croatia and Vinča Institute of Nuclear Sciences Serbia. The project has initiated a strong scientific co-operation, with innovative approaches, and high scientific level, in order to correlate ICT last generation solutions, procedures and techniques from fossil fuelled burning processes thermodynamics, mathematical modelling, modern methods of flue gases analysis, combustion control and AIS systems with focus on Expert Systems category in an optimal form.

Nomenclature

C	– mass content of carbon in fuel, [kg _C kg _f ⁻¹]
H	– mass content of hydrogen in fuel, [kg _H kg _f ⁻¹]
dNO_x/dt	– NO _x formation rate, [kg _s ⁻¹]
O_2	– oxygen concentration, [%]
r	– reactions coefficients, [-]
S	– mass content of sulphur in fuel, [kg _S kg _f ⁻¹]
v_a	– specific volume of air, [m ³ kg ⁻¹]
W'_f	– fuel mass flow rate, [ks ⁻¹]

Greek symbols

α_0	– reactions coefficients, [-]
α_1	– reactions coefficients, [-]
β	– theoretical oxygen volume percentage for combustion process, [kgm ⁻³]
λ	– real fuel to air ratio, [-]
λ_{st}	– stoichiometric fuel to air ratio, [-]
$\zeta(t)$	– burner tilt position, [%]

References

- [1] Barrett, M., Atmospheric Emissions from Large Point Sources in Europe, Swedish NGO Secretariat on Acid Rain, Goteborg, Sweden, 2004
- [2] Chatel-Pelage, F., *et al.*, Applications of Oxygen for NO_x Control and CO₂ Capture in Coal-Fired Power Plants, *Thermal Science*, 10 (2006), 3, pp. 119-142
- [3] Kaminski, J., Technologies and Costs of SO₂-Emissions Reduction for the Energy Sector, *Applied Energy*, 75 (2003), 3-4, pp. 165-172

- [4] Zheng, L., Shuijun, Y., Minaggo, Y., Monitoring NO_x Emissions from Coal-Fired Boilers Using Generalized Regression Neural Network, *Proceedings*, International Conference on Bioinformatics and Biomedical Engineering, Shanghai, China, 2008, Vol. 1, pp. 1916-1919
- [5] ***, Energy in the Western Balkans, <http://www.iea.org>
- [6] Kazagić, A., Smajević, I., Duić, N., Selection of Sustainable Technologies for Combustion of Bosnian Coals, *Thermal Science*, 14 (2010), 3, pp. 715-727
- [7] Đurić, S., et al., Qualitative Analysis of Coal Combusted in Boilers of Thermal Power Plants in Bosnia and Herzegovina, *Thermal Science*, 16 (2012), 2, pp. 605-612
- [8] Gligorić, Z., et al., Simulation Model – Support to Investment Decision-Making in the Coal Industry, *Thermal Science*, 14 (2010), 3, pp. 835-844
- [9] ***, Instrumentation & Controls – P3000 solution compendium, <http://www.energy.siemens.com>
- [10] Li, S., et al., NO_x Emission and Thermal Efficiency of a 300 MWe Utility Boiler Retrofitted by Air Staging, *Applied Energy*, 21 (2009), 4, pp. 269-360
- [11] Kalogirou, S., Applications of Artificial Neural-Networks for Energy Systems, *Applied Energy*, 67 (2000), 1-2, pp. 17-35
- [12] Zheng, L., et al., A Comparative Study of Optimization Algorithms for Low NO_x Combustion Modification at a Coal-Fired Utility Boiler, *Expert Systems with Application*, 36 (2009), 2, pp. 2780-2793
- [13] Sijerčić, M., Belošević, S., Stefanović, P., Modeling of Pulverized Coal Combustion Stabilization by Means of Plasma Torch, *Thermal Science*, 9 (2005), 2, pp. 57-72
- [14] Filkoski, R., Petrovski, I., Karas, P., Optimisation of Pulverised Coal Combustion by Means of CFD/CTA Modelling, *Thermal Science*, 10 (2006), 3, pp. 161-179
- [15] Kalogirou, S., Artificial Intelligence for the Modeling and Control of Combustion Processes: A Review, *Renewable and Sustainable Energy Reviews*, 5 (2001), 4, pp. 373-401
- [16] Yap, W. K., Karri, V., ANN Virtual Sensors for Emissions Prediction and Control, *Applied Energy*, 88 (2011), 12, pp. 4505-4519
- [17] Čojbašić, Ž., et al., Computationally Intelligent Modelling and Control of Fluidized Bed Combustion Process, *Thermal Science*, 15 (2011), 2, pp. 321-338
- [18] Li, N., Thompson, S., Modelling of Combustion and Emissions for a Cyclic Power Plant, *Proceedings*, 13th Triennial World Congress, San Francisco, Cal., USA, 1996, Vol. 1, pp. 37-42